



Surface-Mount PAR[®] Transient Voltage Suppressors

High Temperature Stability and High Reliability Conditions



SMB (DO-214AA)



PRIMARY CHARACTERISTICS	
V _{BR}	12 V to 100 V
V _{WM}	10.2 V to 85.5 V
P _{PPM}	1500 W
T _J max.	185 °C
Polarity	Bidirectional
Package	SMB (DO-214AA)

TYPICAL APPLICATIONS

Use in sensitive electronics protection against voltage transients induced by inductive load switching and lightning on ICs, MOSFET, signal lines of sensor units for automotive.

FEATURES

- Junction passivation optimized design passivated anisotropic rectifier technology
- T_J = 185 °C capability suitable for high reliability and automotive requirement
- 1500 W peak pulse power capability with a 10/1000 μs waveform
- Bidirectional
- Excellent clamping capability
- Very fast response time
- Meets MSL level 1, per J-STD-020, LF maximum peak of 260 °C
- AEC-Q101 qualified
- Material categorization: for definitions of compliance please see www.vishay.com/doc?99912



MECHANICAL DATA

Case: SMB (DO-214AA)

Molding compound meets UL 94 V-0 flammability rating

Base P/NHM3 - halogen-free, RoHS-compliant, and AEC-Q101 qualified

Terminals: matte tin plated leads, solderable per J-STD-002 and JESD 22-B102

HM3 suffix meets JESD 201 class 2 whisker test

Polarity: no cathode band for bidirectional types

MAXIMUM RATINGS (T _A = 25 °C, unless otherwise noted)			
PARAMETER	SYMBOL	VALUE	UNIT
Peak pulse power dissipation with a 10/1000 μs waveform (fig.1) ⁽¹⁾	P _{PPM}	1500	W
Peak pulse current with a 10/1000 μs waveform (fig.3) ⁽¹⁾	I _{PPM}	See table next page	A
Operating junction and storage temperature range	T _J , T _{STG}	-65 to +185	°C

Note

⁽¹⁾ Non-repetitive current pulse, per fig.3 and derated above T_A = 25 °C per fig.2



ELECTRICAL CHARACTERISTICS (T _A = 25 °C, unless otherwise noted)										
DEVICE TYPE	DEVICE MARKING CODE	BREAKDOWN VOLTAGE V _{BR} ⁽¹⁾ AT I _T (V)			TEST CURRENT I _T (mA)	STAND-OFF VOLTAGE V _{WM} (V)	MAXIMUM REVERSE LEAKAGE AT V _{WM} I _R (μA)	MAXIMUM REVERSE LEAKAGE AT V _{WM} T _J = 150 °C I _R (μA)	MAXIMUM PEAK PULSE SURGE CURRENT I _{PPM} ⁽²⁾ (A)	MAXIMUM CLAMPING VOLTAGE AT I _{PPM} V _C (V)
		MIN.	NOM.	MAX.						
T15B12CA	KX5	11.4	12.0	12.6	1.0	10.2	2.0	12.0	91.2	17.0
T15B13CA	KZ5	12.4	13.0	13.7	1.0	11.1	2.0	10.0	83.8	18.5
T15B15CA	LG5	14.3	15.0	15.8	1.0	12.8	1.0	10.0	73.1	21.2
T15B16CA	LK5	15.2	16.0	16.8	1.0	13.6	1.0	10.0	68.9	22.5
T15B18CA	LM5	17.1	18.0	18.9	1.0	15.3	1.0	10.0	60.8	25.5
T15B20CA	LR5	19.0	20.0	21.0	1.0	17.1	1.0	10.0	56.0	27.7
T15B22CA	LS5	20.9	22.0	23.1	1.0	18.8	1.0	10.0	50.7	30.6
T15B24CA	LV5	22.8	24.0	25.2	1.0	20.5	1.0	10.0	46.7	33.2
T15B27CA	LW5	25.7	27.0	28.4	1.0	23.1	1.0	10.0	41.3	37.5
T15B30CA	ME5	28.5	30.0	31.5	1.0	25.6	1.0	10.0	37.4	41.4
T15B33CA	MG5	31.4	33.0	34.7	1.0	28.2	1.0	10.0	33.9	45.7
T15B36CA	MJ5	34.2	36.0	37.8	1.0	30.8	1.0	15.0	31.1	49.9
T15B39CA	MM5	37.1	39.0	41.0	1.0	33.3	1.0	15.0	28.8	53.9
T15B43CA	MN5	40.9	43.0	45.2	1.0	36.8	1.0	20.0	26.1	59.3
T15B47CA	MR5	44.7	47.0	49.4	1.0	40.2	1.0	20.0	23.9	64.8
T15B51CA	MT5	48.5	51.0	53.6	1.0	43.6	1.0	20.0	22.1	70.1
T15B56CA	MX5	53.2	56.0	58.8	1.0	47.8	1.0	20.0	20.1	77.0
T15B62CA	MZ5	58.9	62.0	65.1	1.0	53.0	1.0	20.0	18.2	85.0
T15B68CA	NF5	64.6	68.0	71.4	1.0	58.1	1.0	20.0	16.8	92.0
T15B75CA	NL5	71.3	75.0	78.8	1.0	64.1	1.0	20.0	14.9	104
T15B82CA	NP5	77.9	82.0	86.1	1.0	70.1	1.0	20.0	13.7	113
T15B91CA	NT5	86.5	91.0	95.5	1.0	77.8	1.0	20.0	12.4	125
T15B100CA	NV5	95.0	100	105	1.0	85.5	1.0	20.0	11.3	137

Notes

- (1) V_{BR} measured after I_T applied for 300 μs, I_T = square wave pulse or equivalent
- (2) Surge current wave form per fig.3 and derated per fig.2
- (3) All terms and symbols are consistent with ANSI/IEEE C62.35

IMMUNITY TO STATIC ELECTRICAL DISCHARGE TO THE FOLLOWING STANDARDS (T _A = 25 °C unless otherwise noted)				
STANDARD	TEST TYPE	TEST CONDITIONS	SYMBOL	VALUE
IEC 61000-4-2	Contact discharge	C = 150 pF, R = 330 Ω	ESD	30 kV
	Air discharge			30 kV

THERMAL CHARACTERISTICS (T _A = 25 °C unless otherwise noted)				
PARAMETER	SYMBOL	TYP.	MAX.	UNIT
Thermal resistance	R _{θJA} ⁽¹⁾	110	130	°C/W
	R _{θJM} ⁽²⁾	4.5	6.0	°C/W

Notes

- (1) Thermal resistance junction-to-ambient to follow JEDEC® 51-2A, device mounted on FR4 PCB, 2 oz. standard footprint
- (2) Thermal resistance junction-to-mount to follow JEDEC® 51-14 using Transient Dual Interface Test Method (TDIM)

ORDERING INFORMATION (Example)				
PREFERRED P/N	UNIT WEIGHT (g)	PREFERRED PACKAGE CODE	BASE QUANTITY	DELIVERY MODE
T15B12CAHM3/H ⁽¹⁾	0.107	H	750	7" diameter plastic tape and reel
T15B12CAHM3/I ⁽¹⁾	0.107	I	3200	13" diameter plastic tape and reel

Note

- (1) AEC-Q101 qualified



RATINGS AND CHARACTERISTICS CURVES ($T_A = 25\text{ }^\circ\text{C}$, unless otherwise noted)

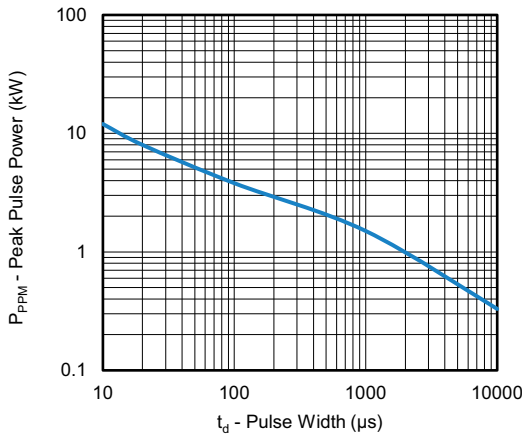

Fig. 1 - Peak Pulse Power Rating Curve

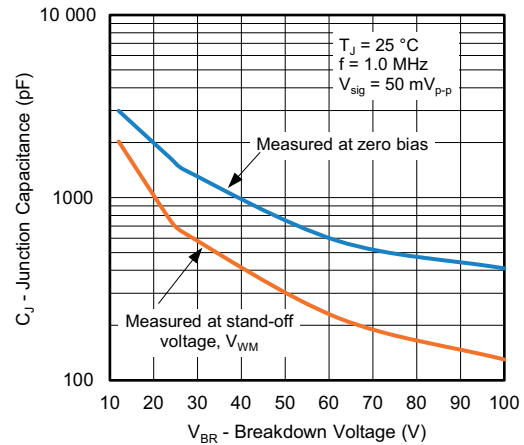

Fig. 4 - Typical Junction Capacitance

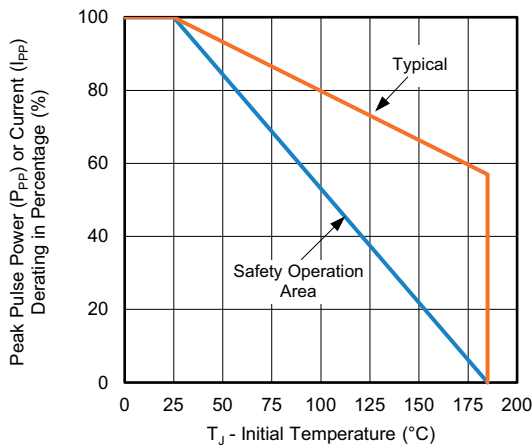

Fig. 2 - Pulse Power or Current vs. Initial Junction Temperature

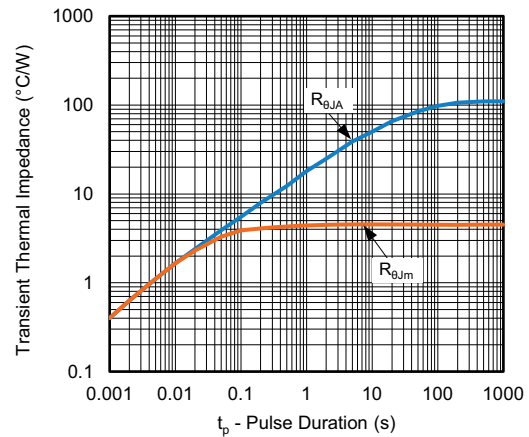

Fig. 5 - Typical Transient Thermal Impedance

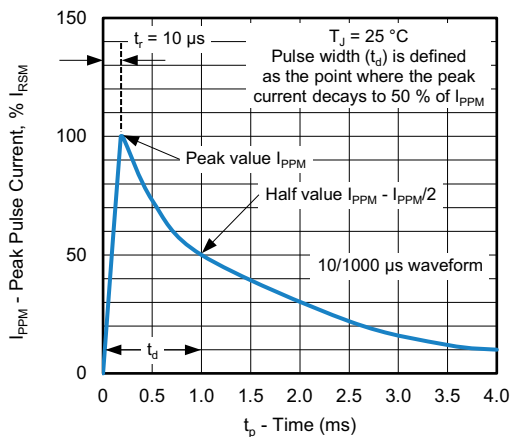

Fig. 3 - Pulse Waveform

Note

- Fig.1, power calculations is based on I_{PPM} times defined maximum clamping voltage by pulse width



PACKAGE OUTLINE DIMENSIONS in inches (millimeters)

SMB (DO-214AA)

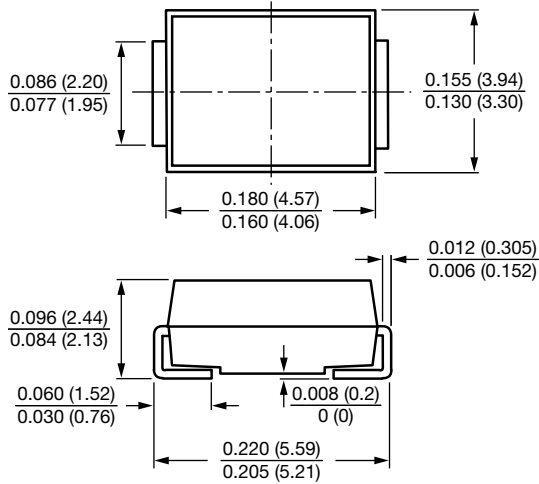

Mounting Pad Layout

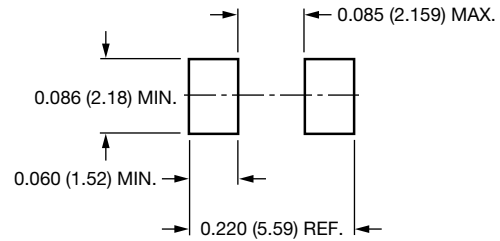



Disclaimer

ALL PRODUCT, PRODUCT SPECIFICATIONS AND DATA ARE SUBJECT TO CHANGE WITHOUT NOTICE TO IMPROVE RELIABILITY, FUNCTION OR DESIGN OR OTHERWISE.

Vishay Intertechnology, Inc., its affiliates, agents, and employees, and all persons acting on its or their behalf (collectively, "Vishay"), disclaim any and all liability for any errors, inaccuracies or incompleteness contained in any datasheet or in any other disclosure relating to any product.

Vishay makes no warranty, representation or guarantee regarding the suitability of the products for any particular purpose or the continuing production of any product. To the maximum extent permitted by applicable law, Vishay disclaims (i) any and all liability arising out of the application or use of any product, (ii) any and all liability, including without limitation special, consequential or incidental damages, and (iii) any and all implied warranties, including warranties of fitness for particular purpose, non-infringement and merchantability.

Statements regarding the suitability of products for certain types of applications are based on Vishay's knowledge of typical requirements that are often placed on Vishay products in generic applications. Such statements are not binding statements about the suitability of products for a particular application. It is the customer's responsibility to validate that a particular product with the properties described in the product specification is suitable for use in a particular application. Parameters provided in datasheets and / or specifications may vary in different applications and performance may vary over time. All operating parameters, including typical parameters, must be validated for each customer application by the customer's technical experts. Product specifications do not expand or otherwise modify Vishay's terms and conditions of purchase, including but not limited to the warranty expressed therein.

Hyperlinks included in this datasheet may direct users to third-party websites. These links are provided as a convenience and for informational purposes only. Inclusion of these hyperlinks does not constitute an endorsement or an approval by Vishay of any of the products, services or opinions of the corporation, organization or individual associated with the third-party website. Vishay disclaims any and all liability and bears no responsibility for the accuracy, legality or content of the third-party website or for that of subsequent links.

Except as expressly indicated in writing, Vishay products are not designed for use in medical, life-saving, or life-sustaining applications or for any other application in which the failure of the Vishay product could result in personal injury or death. Customers using or selling Vishay products not expressly indicated for use in such applications do so at their own risk. Please contact authorized Vishay personnel to obtain written terms and conditions regarding products designed for such applications.

No license, express or implied, by estoppel or otherwise, to any intellectual property rights is granted by this document or by any conduct of Vishay. Product names and markings noted herein may be trademarks of their respective owners.