



ALUMINUM CAPACITORS

Power Supplies



Capacitors - Aluminum in Power Supplies

Engineering Solutions

Aluminum Capacitors in Power Supplies



TABLE OF CONTENTS

- Introduction 02
- Construction and Characteristics..... 03
 - Internal Construction..... 03
 - Electrical Characteristic 04
- Selecting Aluminum Capacitors 07
 - Minimum Capacitance 07
 - Lifetime..... 08
 - Operating Temperature – Ohmic Losses, Ripple Currents and Heat Dissipation 08
 - Ripple Current and Lifetime Calculations..... 10
- Other Practical Issues 15
 - Maximum ESR 15
 - Leakage Current and Shelf Life..... 15
 - Connecting Aluminum Capacitors in Parallel..... 16
 - Connecting Aluminum Capacitors in Series 16
 - Mechanical Considerations..... 17
- Vishay Aluminum Capacitor Range..... 18

RESOURCES

- For technical questions contact aluminumcaps2@vishay.com
- Sales Contacts: <http://www.vishay.com/doc?99914>

One of the World's Largest Manufacturers of
Discrete Semiconductors and Passive Components





ALUMINUM CAPACITORS

Introduction



Capacitors - Aluminum in Power Supplies

Introduction

Figure 1 shows the basic topology of a power supply and Table 1 indicates the functions of the aluminum capacitor based on its circuit location. In general, aluminum capacitors are the most suitable capacitors for addressing requirements such as low and high frequency filtering and energy storage, which demand high capacitance values and power ratings. The devices offer high CU/(unit cost) ratios, are small compared with other technologies, and are relatively insensitive to voltage spikes. Furthermore, they are available in a broad range of sizes.

While it is easy to regard aluminum capacitors as commodity products, they are, after inductors, often the most expensive passive components in the power supply. Because of this, designers must pay careful attention to selection. However, selecting an aluminum capacitor is not as straightforward as it might seem — there are many different types to choose from and data books offer a wealth of information that is not always easy to interpret. Circuit simulation programs further complicate the situation, as they cannot easily handle frequency dependent component characteristics. For accurate simulation, the designer must enter the most suitable parameter values for the specified operating conditions. This, in turn, demands a clear understanding of the aluminum capacitor’s frequency dependent behavior. In addition, designers must also understand how this behavior changes over time to ensure reliable operation throughout application lifetime.

This document has been written to provide an insight into the technology and characteristics of aluminum capacitors with respect to their use in power supplies. Reading this document will help the designer to interpret aluminum capacitor datasheets and to appreciate both the advantages and limitations of these products. Using this information and the calculation tools provided will help designers to make truly informed decisions when selecting an aluminum capacitor for their power supply application.

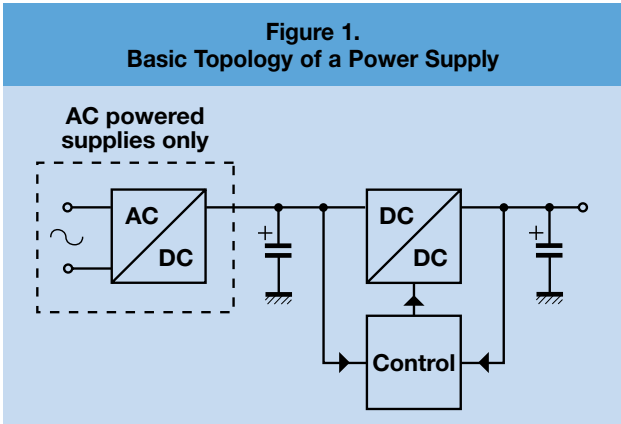

Table 1. Functions of Aluminum Capacitor and its Influence on the Circuit

Circuit Location	Function of Aluminum Capacitor	Potential Problem Sources
Input buffer (mains input or DC input)	<ul style="list-style-type: none"> Provides energy when mains input voltage is too low Stores energy while AC/DC converter, e.g. a PFC controller, adapts to a new power level Prevents HF switching noise from the DC/DC converter reaching power source 	<ul style="list-style-type: none"> Decrease of capacitance, capacitor voltage drops below minimum input voltage of DC/DC converter Increase of ESR will increase HF voltage noise on aluminum capacitor and decrease its filtering function
Output buffer	<ul style="list-style-type: none"> Current sink for inductor (current to voltage conversion), filtering Buffer energy while DC/DC converter adapts to changed power output 	<ul style="list-style-type: none"> Increase of ESR will increase ripple voltage on output and may influence stability of control loop Decrease of capacitance will cause larger voltage undershoot/overshoot



ALUMINUM CAPACITORS

Construction and Characteristics



Capacitors - Aluminum in Power Supplies

Internal Construction

As Figure 2 shows, modern, non-solid aluminum capacitors comprise a cylindrical winding made up of the following:

- An electrochemically etched aluminum anode foil forming the first plate of the capacitor
- An oxide layer on the etched aluminum foil that forms the dielectric
- A paper spacer impregnated with fluid electrolyte in contact with the oxide layer to form the second plate of the capacitor
- A second foil that forms the other contact with the fluid electrolyte

In non-solid aluminum capacitors, the fluid electrolyte forming the second plate of the capacitor penetrates the pores of the anode oxide layer to provide the maximum surface contact and, therefore, ensure high capacitance values.

In the case of solid aluminum capacitors and tantalum chips, the second plate of the capacitor is formed by impregnating the pores of the anode oxide layer with a fluid that is then specially processed to convert it into a solid.

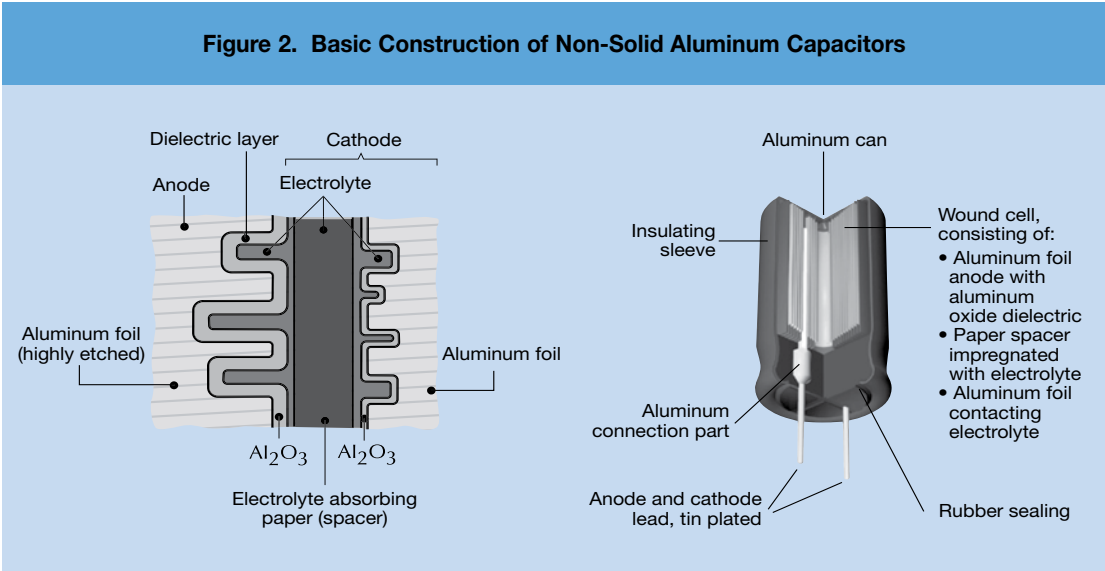



ALUMINUM CAPACITORS

Construction and Characteristics



Electrical Characteristics

The charge transport to and from the anode oxide layer of a non-solid aluminum capacitor occurs via the electrolyte and, because of the electrolyte's limited, temperature-dependent conductivity, this leads to ohmic losses. In addition, the aluminum oxide itself also gives rise to ohmic losses that decrease strongly with frequency. At very high frequencies the skin effect forces the current to only flow at the surface of the aluminum foils, increasing ohmic losses.

All of the contributions to the capacitor's ohmic losses can be summarized into an equivalent series resistor (ESR). This results in the often used equivalent AC circuit for an aluminum capacitor as shown in Figure 3. Note this is an AC model only, so R_A and R_C represent the frequency dependent losses associated with the anode foil (R_A) and the electrolyte contact foil (R_C). They should not be confused with the parallel resistors sometimes used in a DC model to represent leakage current.

The examples in Figure 4a and 5a illustrate that ESR is not a simple, single-valued quantity but is strongly dependent on the frequency and temperature at which it is measured. Figure 4b and 5b show that the same is true of capacitance. Capacitance changes because the resistance of the electrolyte in the minute pores of the anode oxide combines with the capacitance in the pores to form a low-pass network. At high frequency, a greater proportion of the capacitance in the pores becomes isolated until only surface capacitance remains. At low temperatures, the lower conductivity of the electrolyte decreases the frequency where this effect starts. Note that in Figure 4b and 5b the higher frequency measurement data is not shown, as it is distorted by the effect of the component's inductance.

The presence of the fluid electrolyte also results in variations of electrical characteristics over time. Even at room temperature part of the electrolyte inside the aluminum capacitor will vaporize and, while the vaporized electrolyte cannot escape directly into the air because of the capacitor's sealed case, it will diffuse through the seal itself. As a result, an aluminum capacitor loses electrolyte slowly but steadily over time, and the device dries out. The lower the temperature of the aluminum capacitor, the slower the drying out process and, therefore, the longer the useful life of the device.

Both the ambient temperature and the heat generated by ohmic losses when current flows determine the temperature of the aluminum capacitor, and both have a similar influence on the drying out process. As the amount of fluid electrolyte in the aluminum capacitor decreases, the ohmic losses or ESR increase because less electrolyte is available to transport the charge to and from the anode oxide. At the same time, capacitance decreases as the electrolyte can no longer be in contact with the entire surface in the pores of the etched anode.

These changes in electrical characteristics ultimately prevent the circuit from functioning as intended, at which time the lifetime of the aluminum capacitor is over.

Aluminum capacitors are most commonly used in a power supply circuit as a buffer, to store electrical energy, or as a part of a low- or high-pass filter. For both functions, it is sufficient to calculate the required (minimum) capacitance. However, the specific construction and properties of aluminum capacitors also require verification of other parameters to ensure a long and trouble free operating life.

Figure 3. Equivalent AC Circuit

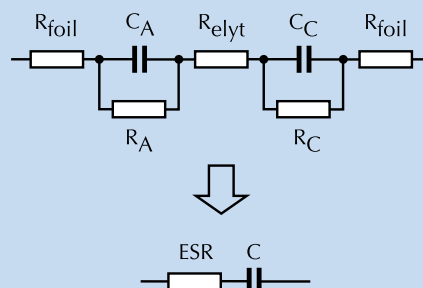



ALUMINUM CAPACITORS

Construction and Characteristics



Capacitors - Aluminum in Power Supplies

Figure 4a.
Example of High Voltage ESR Characteristics (159 PUL-SI, 330 μ F/400 V at 0 h)

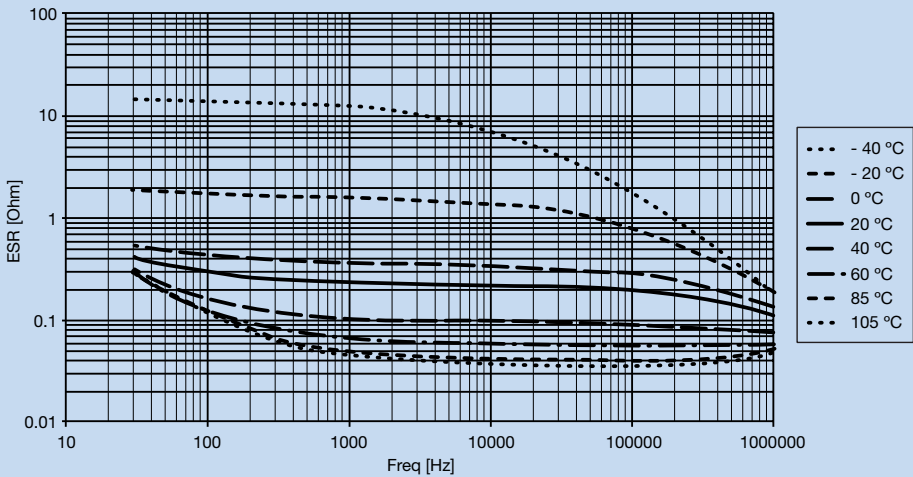
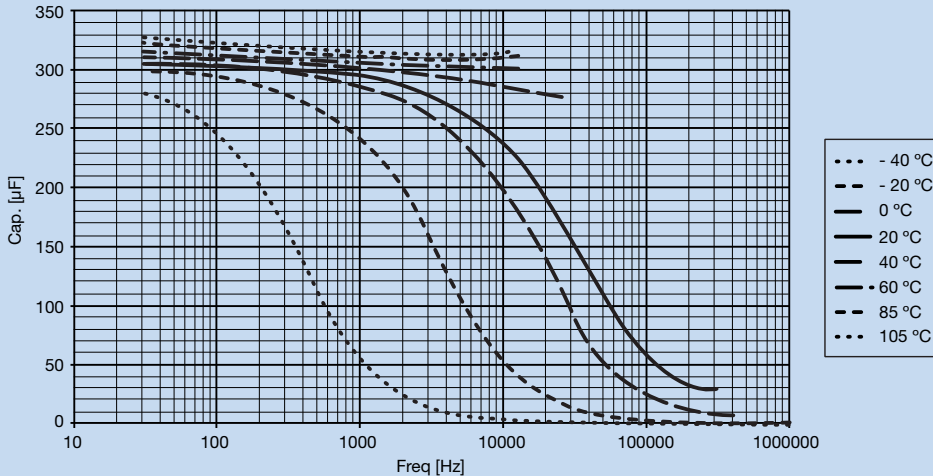

Figure 4b.
Example of High Voltage Capacitance Characteristics (159 PUL-SI, 330 μ F/400 V at 0 h)





ALUMINUM CAPACITORS

Construction and Characteristics



Capacitors - Aluminum in Power Supplies

Figure 5a.
Example of Low Voltage ESR Characteristics (136 RVI, 1000 μ F/50 V at 0 h)

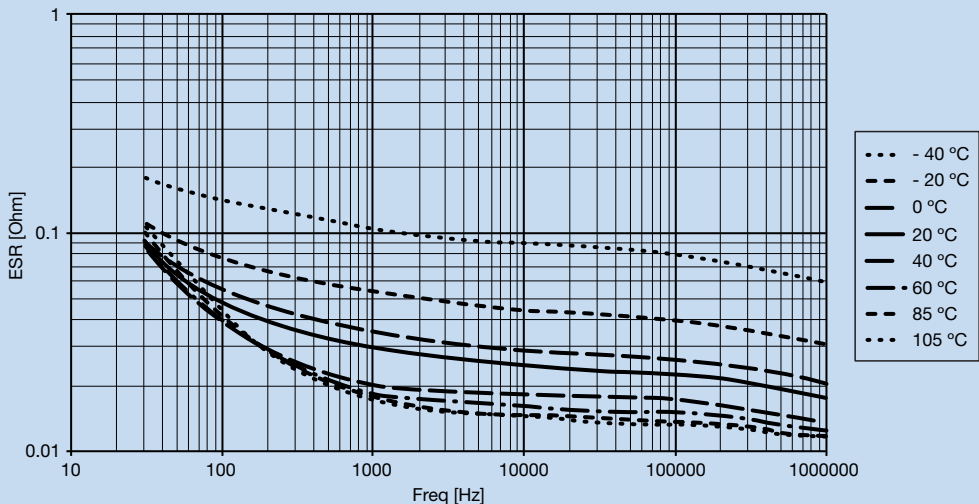
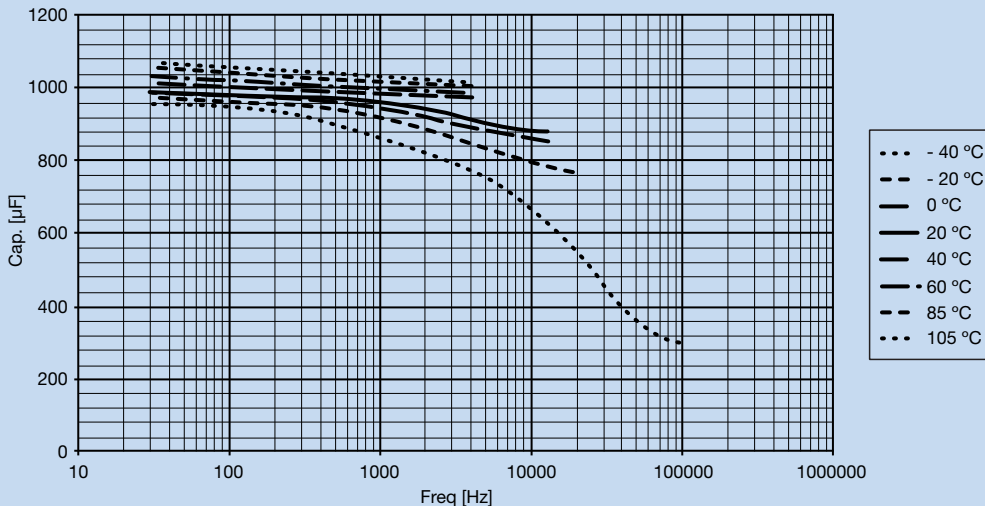

Figure 5b.
Example of Low Voltage Capacitance Characteristics (136 RVI, 1000 μ F/50 V at 0 h)





ALUMINUM CAPACITORS

Selecting Aluminum Capacitors



Minimum Capacitance

When selecting the capacitance of an aluminum capacitor for a circuit, the usual capacitor equations apply:

$$f_{-3dB} = \frac{1}{2 \cdot \pi \cdot R \cdot C} \quad [1]$$

(DC - decoupling, filtering)

$$P \cdot \Delta t = \frac{1}{2} \cdot C \cdot (U_t^2 - U_{t+\Delta t}^2) \quad [2]$$

(Buffering, energy storage)

Equation 1, applicable to simple RC-filter configurations, requires little explanation. Although for low temperatures and higher frequencies, the influence of ESR, which does not feature in this equation, cannot always be neglected. Note that in many cases, the value of R is not obvious from the schematic diagram, e.g. when it is the series resistance of a diode in the rectifier bridge.

Equation 2 shows the relation between the change in energy stored in the aluminum capacitor ($E = \frac{1}{2} CU^2$), and the power taken from or stored in the aluminum capacitor over time Δt . This equation can be used to calculate the minimum capacitance for the mains input buffer (see Example 1). Note that this minimum capacitance requirement must also be met at the end of useful life, which for some aluminum capacitors is reached when the capacitance has dropped by 30 %.

Example 1. Calculating the Minimum Required Capacitance

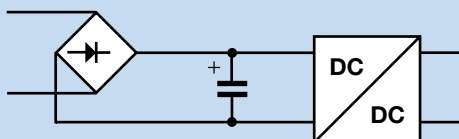

Power supply: 100 W, 85 % efficiency, 20 ms holdup time, 220 V \pm 10 % input voltage. The flyback converter in the power supply requires a minimum input voltage of 80 V.

$$P = \frac{100}{0.85} = 118 \text{ W} \quad \Delta t = 20 \text{ ms}$$

$$U_t = 220 \cdot (1 - 0.10) \cdot \sqrt{2} = 280 \text{ V} \quad U_{t+\Delta t} = 80 \text{ V}$$

$$C_{\min} = \frac{2 \cdot P \cdot \Delta t}{(U_t^2 - U_{t+\Delta t}^2)} = \frac{2 \cdot 118 \cdot 20 \cdot 10^{-3}}{280^2 - 80^2} = 66 \mu\text{F}$$

This is the minimum capacitance at which the circuit will meet its requirements. This minimum capacitance must be available at the end of the targeted application life. If the capacitance is expected to be reduced, e.g. by 15 % at the end of life, a value of 78 μF is required to ensure proper circuit function during the full life of the application.

$$C_{\text{end}} = \frac{1}{(1 - 0.15)} \cdot C_{\min} = \frac{1}{0.85} \cdot 66 \mu\text{F} = 78 \mu\text{F} \Rightarrow \text{use } 100 \mu\text{F} \pm 20 \%$$



ALUMINUM CAPACITORS

Selecting Aluminum Capacitors



Lifetime

The lifetime of an aluminum capacitor ends when it no longer functions in the application as intended by the designer of the application. For the input buffer capacitor of a power supply, its lifetime ends when the capacitance drops below the value needed to supply energy to the DC/DC converter when the mains voltage is too low. For the output buffer capacitor of a power supply, its lifetime ends when its impedance increases to a point where the ripple voltage on the output voltage causes problems in the circuits driven by the power supply.

Because end of lifetime is determined by the actual use of the aluminum capacitor, mainly its operating temperature, aluminum capacitor suppliers have created several definitions for a figure of merit, related to lifetime, in order to test their products. The table below provides a description of some examples and their change in parameters defining “end of lifetime”:

Name of Test	Reference	Test Conditions	End of Test Requirements
Endurance	IEC 60384-4, 4.13	Test at max. temperature (T_{UC}) and rated voltage (U_R)	<ul style="list-style-type: none"> - 10 % < $\Delta C/C$ < 10 % (for $U_R > 200$ V) $\tan \delta < 1.3 \times$ stated limit Impedance < 2 x stated limit
Load Life		Test at max. temperature (T_{UC}) and rated voltage (U_R)	<ul style="list-style-type: none"> - 20 % < $\Delta C/C$ < 20 % $\tan \delta < 2 \times$ stated limit
Useful Life	CECC 30301, 1.8.1	Test at max. temperature (T_{UC}), rated voltage (U_R) and rated ripple current (I_R)	<ul style="list-style-type: none"> - 30 % < $\Delta C/C$ < 30 % (for $U_R > 200$ V) $\tan \delta < 3 \times$ stated limit Impedance < 3 x stated limit

To translate the “end of life” specification to “end of life” in the application, a calculation method is used. The calculation method developed by Vishay is described in the next section.

As a side note, in order to verify that aluminum capacitors meet their “end of lifetime” specification, manufacturers must regularly test this value. As shorter test times result in less use of testing resources, testing at high temperatures is preferred to prove longer lifetime at lower temperatures, but this is only possible if the aluminum capacitor is actually designed to handle this high test temperature. This has led to the widely accepted misconception that “105 °C rated capacitors are higher quality than 85 °C capacitors.” This is based on the assumption that both have the same “end of life” specification, but many more items determine the quality of an aluminum capacitor. If the higher maximum temperature is not needed in the application, selecting an 85 °C rated product with longer lifetime can result in a lower cost solution.

Operating Temperature – Ohmic Losses, Ripple Currents, and Heat Dissipation

Where the heat generated by the ohmic losses is negligible — for example with aluminum capacitors used in timing circuits — it is possible to make lifetime calculations based on a rule of thumb derived from the Arrhenius equation. This states that lifetime effectively doubles for every 10 °C decrease in ambient temperature. However, when it comes to the aluminum capacitors in a power supply, such simplification is not possible as the temperature rise due to the ohmic losses during charge and discharge cannot be neglected. Some method, therefore, is needed to take the effect of this temperature rise into account. One of the keys to this is the relation between the heating, the charging/discharging (or ‘ripple’) current, and the ability of the aluminum capacitor to dissipate heat.



ALUMINUM CAPACITORS

Selecting Aluminum Capacitors



Figure 6. A simple thermal model

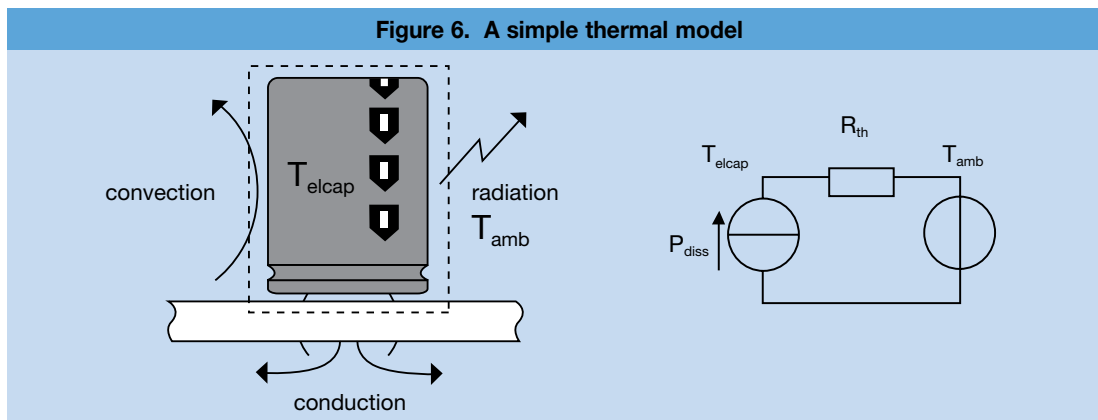

How the capacitor dissipates heat to its environment can be described with a simple thermal model, shown in Figure 6. Inside the dotted line everything has temperature T_{elcap} , outside the dotted line everything has temperature T_{amb} . The heat generated inside the dotted line is transported to outside the dotted line via convection, radiation and conduction, which all require a temperature difference. The electrical analogy is shown on the right side of Figure 6.

Note that R_{th} (in K/W) is the ratio between the temperature difference and the amount of heat being transported. The value of R_{th} is influenced by application conditions, like airflow (convection) or contact with a cool surface (conduction).

Using this simple thermal model, if I_{ripple} designates the RMS value of the ripple current through the aluminum capacitor, the power generated in the aluminum capacitor can be defined as:

$$P_{diss} = ESR \cdot I_{ripple}^2 \quad [3]$$

and the temperature rise of the aluminum capacitor as:

$$\Delta T_{elcap} = R_{th} \cdot P_{diss} = R_{th} \cdot ESR \cdot I_{ripple}^2 \quad [4]$$

However, thermal resistance (R_{th}) and ESR which are both dependent on actual application conditions, are normally not specified by capacitor manufacturers. They typically quote only a rated ripple current (I_R) for a specified frequency and temperature. Thermal models or measurements can be used to determine ESR and R_{th} , but a more straightforward approach is to eliminate them from the calculation by comparing heat dissipation under application conditions with heat dissipation under reference conditions (usually an airflow of < 0.5 m/s). For these reference conditions, data books typically specify rated ripple current I_R as the ripple current resulting in a defined temperature rise:

$$\Delta T_R = R_{th} \cdot ESR \cdot I_R^2 \quad [5]$$

Rated ripple current is a figure of merit indicating how well an aluminum capacitor can handle the ripple current flowing through it. I_R depends on ESR at the specified frequency and temperature, the defined temperature rise, and the aluminum capacitor's heat dissipation capability. Vishay aluminum capacitors, for example, are designed to handle heating caused by the rated ripple current at maximum rated temperature for their specified useful life. Usually rated ripple current is defined at 100 Hz, 120 Hz, or 100 kHz and causes a 5 °C to 10 °C internal temperature rise.

For an application where the main harmonic of the ripple current is the same frequency as that of the rated ripple current (i.e. no correction factors for frequency), I_A equals I_{ripple} and the temperature rise (ΔT_{elcap}) for the application is given by Equation 6.

$$\Delta T_{elcap} = \Delta T_R \cdot \frac{I_A^2}{I_R^2} \quad [6]$$



ALUMINUM CAPACITORS

Selecting Aluminum Capacitors



From this equation, it is easy to see the relation between temperature rise and the parameter I_A/I_R , and thus the link between I_A/I_R and ohmic losses.

Temperature rise calculations become more complicated when the frequency of the application ripple current differs from that of the rated ripple current. Since power dissipation depends on ESR, a correction factor must be introduced to correct for changes in ESR with frequency. The calculations can be simplified with the following assumptions:

- The ripple currents from the different sources are not phase related
- The ripple currents are approximately sinusoidal (e.g. the effects of the higher harmonics are neglected)

In a generalized form, if there are contributions I_{f1} , I_{f2} ... to the ripple current from different sources with main frequencies f_1 , f_2 ... (e.g. 100 Hz from the mains input and 30 kHz from the switching converter), the total heating of the aluminum capacitor will be:

$$\begin{aligned}\Delta T_{\text{elcap}} &= \Delta T_{I_R} \cdot \frac{P_{\text{diss}}}{P_{I_R}} & [7] \\ &= \Delta T_{I_R} \cdot \frac{1}{I_R^2} \left(\left(\frac{I_{f1}}{K_{f1}} \right)^2 + \dots + \left(\frac{I_{fn}}{K_{fn}} \right)^2 \right) \\ &= \Delta T_{I_R} \cdot \frac{I_A^2}{I_R^2}\end{aligned}$$

with

$$K_{fn} = \sqrt{\frac{\text{ESR}_{100 \text{ Hz}}}{\text{ESR}_{fn}}} \quad [8]$$

Note that for Equation 8 it is assumed that I_R is specified at 100 Hz.

Again it is easy to see the relation between the parameter I_A/I_R and the temperature rise caused by the ohmic losses. The only difference now is that calculation of the equivalent application ripple current I_R involves the use of ripple current correction factors (K_{fn}) to compensate for the difference between the ESR at the frequency of the ripple current components and the ESR at the frequency at which I_R is specified. For each series in the Vishay aluminum capacitor family, the data handbook provides a table with the ripple current correction factors which can then be used to calculate the ratio of I_A/I_R .

Temperature rise calculations can become even more complicated when forced cooling is used. Some practical considerations for this situation are covered in a later section. In most cases forced cooling is not used, so there is no additional factor influencing the temperature rise of the aluminum capacitor compared to the reference conditions.

Ripple Current and Lifetime Calculations

Drawing on extensive testing and experience of aluminum capacitors in long-term use, Vishay has developed a graphical tool that shows the relation between the lifetime of the aluminum capacitor in the application and the two sources influencing its temperature. Known as the lifetime nomogram, this tool plots the aluminum capacitor's ambient temperature (T_{amb}) on a horizontal axis against the I_A/I_R parameter described above. Figure 7 shows an example of such a lifetime nomogram.

Example 2 explains how this nomogram can be used to identify an aluminum capacitor with the required ripple current rating and, Example 3 shows how the nomogram can be used to calculate the required specification for useful life.

ALUMINUM CAPACITORS

Selecting Aluminum Capacitors

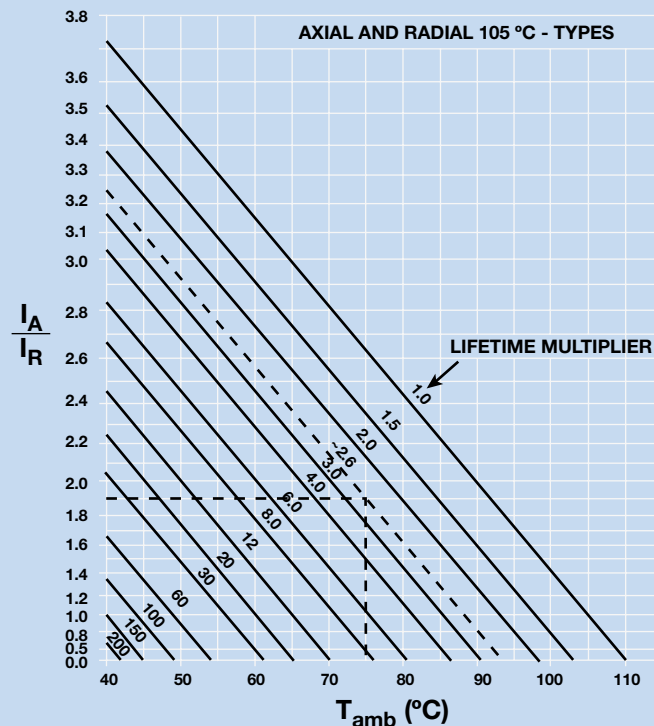
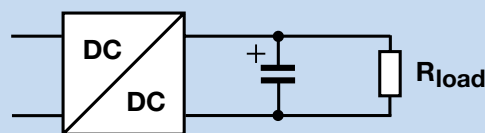
Figure 7. Example of a Lifetime Nomogram (This figure related to Example 2)

Example 2. Using the Lifetime Nomogram to Calculate Required Rated Ripple Current

Power supply output: 5 V, 6 A continuous load, 33 kHz switching frequency. Temperature inside power supply 75 °C, 3 years (= 26280 h) expected lifetime. RMS ripple current through output aluminum capacitor 9 A.

For 150 RMI, larger can sizes, useful life is 10,000 h.

A lifetime multiplier of $\frac{26280}{10000} = 2.6$ is required.

From Figure 7, it can be found that a 75 °C ambient temperature for a lifetime multiplier of 2.6, the following is allowed: $I_A/I_R \approx 1.9$

Ripple current multiplier K_f for a 10 V type for 33 kHz is 1.0 (see data handbook and Equation 7).

The aluminum capacitor to be used on the output must therefore have a rated ripple current of

$$I_R = \frac{1}{\text{multiplier from nomogram}} \cdot \frac{I_A}{K_f} = \frac{1}{1.9} \cdot \frac{9}{1.0} = 4.7 \text{ A}$$

This ripple current can be handled by two series 150 RMI aluminum capacitors of 4700 μF /10 V connected in parallel.



ALUMINUM CAPACITORS

Selecting Aluminum Capacitors



Example 3. Using the Lifetime Nomogram to Calculate Required Specification for Useful Life

The power supply in a television is expected to operate for 5 years, with 8 hours viewing time per day. The maximum air temperature in the television is estimated to be 60 °C when in operation. The maximum air temperature in the television is estimated to be 40 °C when not in operation. In operation, the ripple current through the aluminum capacitor is 50% higher than the rated value (i.e. $I_A/I_R = 1.5$).

Assuming that the nomogram example from Figure 7 can be used (e.g. if the target aluminum capacitor is a radial 105 °C type), the following table can be made (1 year = 8760 h):

	In Years	In Hours	Life Multiplier (Figure 7)	Aluminum Capacitor Life (in h at 105 °C)
Operating, 60 °C, $I_A/I_R = 1.5$	1.7	14600	12	1217
Standby, 40 °C, $I_A/I_R = 0.0$	3.3	29200	200	146
Total	5.0	43800		1363

To meet the required application life, the target aluminum capacitor must have a useful life > 1363 h at 105 °C.

How to Obtain the Data for the Ripple Current Calculation

If a circuit simulator is used in the design phase of the power supply, the results of the simulation can be used to obtain the RMS values for the aluminum capacitor's ripple current components. If this option is no longer available, the ripple current components can also be approximated using, for example, an oscilloscope that can calculate the RMS value and the frequency spectrum of the measured signal. When doing so, it is worth considering the following points:

- A current probe hardly changes the ripple current in the aluminum capacitor when it is introduced in the circuit but usually has a limited lower bandwidth and might not be able to correctly measure 100 Hz components. Some current probes will saturate when the current value is outside the measuring range, resulting in incorrect readings.
- A low-inductance (SMD) resistor, like Vishay's WSR series resistors (www.vishay.com/ppg?30101), can be placed in series with the aluminum capacitor. The value of this resistor must be smaller than the ESR of the aluminum capacitor (a good value is 10 mΩ) so as not to influence the measurement of the high frequency components. Soldering a coaxial cable directly over the resistor will give less interference in the measurement signal than using a probe. It is important to take care when connecting the circuit ground (usually one of the mains phases for the input aluminum capacitor) to the oscilloscope ground, which is earthed. Short circuits need to be avoided and an isolation transformer must be used to separate the aluminum capacitor circuit from the mains.
- It is a good idea to verify that the sum of the RMS values of the main frequency components from the different sources in the frequency domain add up to a value close to the RMS value of the signal in the time domain. If this is not the case, all components can be multiplied by the ratio of the value found in the time domain to the total value found in the frequency domain. The following equation must be used to add up the RMS values for the various frequency components:

$$I_{\text{total}} = \sqrt{I_{f1}^2 + I_{f2}^2 + \dots + I_{fn}^2} \quad [9]$$

These corrected RMS values can be used in Equation 7 to determine the value of parameter I_A/I_R , which is needed to determine the lifetime multiplier from the nomogram.



ALUMINUM CAPACITORS

Selecting Aluminum Capacitors



Temperature and Heat Dissipation Considerations

An aluminum capacitor's temperature rating is the maximum ambient temperature at which the specified useful life is obtained at the rated ripple current and rated voltage. In reality, the measured temperature on the aluminum capacitor may be as much as 10 °C higher due to the effects of ripple current heating.

Ambient temperature as used in the nomograms is defined by IEC 60068 paragraph 4.6.2 as the temperature in still air conditions at such a distance that the effect of dissipation is negligible. However, measuring ambient temperature within a power supply is difficult, although as a first approximation it is possible to use the measured case temperature of the aluminum capacitor. If the equivalent application ripple current I_A is larger than the rated ripple current I_R of the aluminum capacitor, I_A/I_R is >1 and the application may cause significant heating of the device. To ensure that the calculated lifetime correctly reflects the application conditions, another measuring point must be used to estimate the ambient air temperature.

If the heating of the aluminum capacitor by the ripple current is such that the required lifetime cannot be met, it may be necessary to improve cooling, in which case the following tips may be helpful.

Radiation

Aluminum capacitors lose a significant amount of heat by radiation. A surface that cools by radiation can just as easily be heated by radiation.

To avoid overheating, the aluminum capacitor should not be placed close to a hot component such as a heatsink or a transformer.

Convection

Air quickly warms up when flowing over a hot component. If several equally loaded aluminum capacitors (for example parallel aluminum capacitors on a power supply output) are cooled by a fan, it is best to place them on a line perpendicular to the airflow with adequate spacing between them (typically this distance will be no less than half the aluminum capacitor's diameter). This ensures that all devices receive cooling by air of the same temperature. Figure 8 illustrates the effect of airflow on ripple current.

Figure 8. Transport of Heat from the Aluminum Capacitor to its Environment and the Effect of Airflow

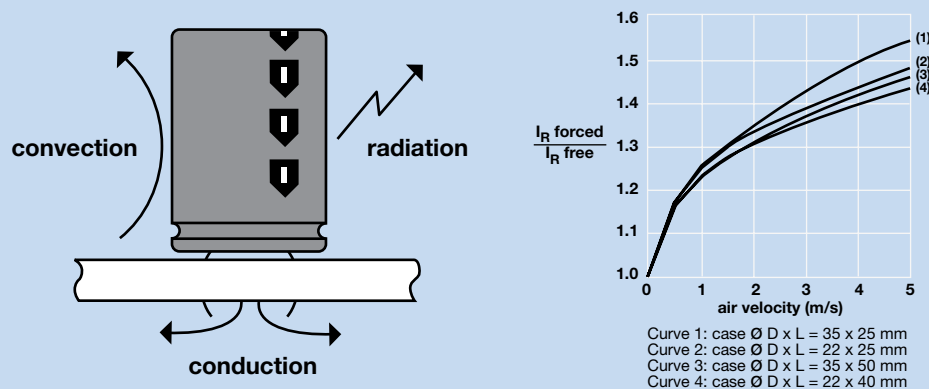



ALUMINUM CAPACITORS

Selecting Aluminum Capacitors



Conduction

In most applications, a limited amount of heat is transported away by conduction via the capacitor terminals to the PC-board. But cooling by conduction can be much more effective than cooling by radiation or convection. Mounting an aluminum capacitor with its base in contact with a (cool) heatsink will lower its temperature significantly.

Note that improved cooling changes the application conditions from the reference conditions, which again results in the addition of a correction factor. In some cases it is easier to determine the proper values for R_{th} and ESR and calculate the expected operating temperature of the aluminum capacitor. Using this temperature as T_{amb} in the nomogram with $I_A/I_R = 0$ allows the proper lifetime multiplier to be determined.



ALUMINUM CAPACITORS

Other Practical Issues



Maximum ESR

It has already been mentioned that at high frequencies and low temperatures the value of ESR cannot be neglected. So far it has been related only to ohmic losses and heating due to ripple current. However, the ESR of the aluminum capacitor can cause another effect, especially for frequencies greater than 10 kHz where it is the dominant contribution to aluminum capacitor impedance.

Consider the simple equivalent circuit for the aluminum capacitor in Figure 3. When a current charges/discharges the aluminum capacitor, it results in an increasing/decreasing voltage across the capacitor (because $I = C \cdot dU/dt$) and a voltage drop over the ESR (because $U = I \cdot \text{ESR}$).

If the aluminum capacitor is charged by low duty cycle, high frequency current pulses (a typical situation for the output capacitor of a flyback power supply) the ripple caused by the voltage drop over the ESR can be higher than the ripple caused by the charging/discharging of the capacitor (see Figure 9).

The maximum ripple allowed on the output voltage then determines the required maximum ESR for the aluminum capacitor. It should again be emphasized that high frequency ESR is temperature dependent and, as the aluminum capacitor warms up, its ESR will drop. Ripple voltage will, therefore, decrease as the power supply warms up.

The lowest high frequency ESR is obtained by selecting a low ESR series (optimal materials), a thin and long case size (low foil resistance), and a large size (more foil to contact paper/electrolyte). As aluminum capacitors generally have only two connections to the foil, many smaller aluminum capacitors in parallel will deliver lower high frequency ESR than a single large aluminum capacitor. Multitab constructions, as used in screw terminal type capacitors, in fact realize multiple capacitors in parallel in the same housing.

In the design of a power supply, more situations occur where the use of an aluminum capacitor requires special consideration. This can be when an aluminum capacitor is stored for a long time before use, when it is connected in parallel or in series, or when the mechanical design of the aluminum capacitor has a major impact on the design of the power supply.

Figure 9. Voltage Ripple on Aluminum Capacitors without and with ESR

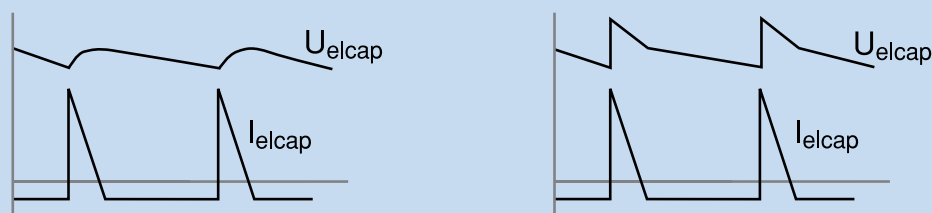

Leakage Current and Shelf Life

Leakage current is a DC characteristic that occurs due to the fact that the aluminum capacitor's electrolyte chemically reacts with the aluminum oxide layer to slowly dissolve it. Applying a voltage induces an electrochemical reaction that rebuilds this layer. As the weak spots in the oxide layer are rebuilt, the current drops to the level required to balance the chemical reaction that is dissolving the aluminum oxide. The current feeding the electrochemical reaction is the leakage current.

If an aluminum capacitor has not been used for several years, the reduced oxide thickness causes increased leakage current to flow when power is first applied. The heat dissipation caused by this leakage current can damage the aluminum capacitors. The shelf life indicates the time the aluminum capacitors can be stored without causing a significant increase in leakage current. Shelf life under normal storage conditions is 3, 4, and 10 years for resp. 85 °C, 105 °C, and 125 °C rated products (www.vishay.com/doc?28356).



ALUMINUM CAPACITORS

Other Practical Issues



If, after storage, it is found that the leakage current is too high, applying a voltage to the aluminum capacitor before it is built into the power supply will restore the oxide layer. To prevent overheating, the aluminum capacitor current must be limited. The formula below can be used to determine a safe maximum current for this procedure.

$$I_{\max} = A_{\text{surf}} / U_R \quad [10]$$

I_{\max} is the maximum current in mA, A_{surf} the aluminum capacitor's surface area in mm², and U_R the rated voltage of the capacitor in V. The voltage over the aluminum capacitor should not exceed U_R .

Connecting Aluminum Capacitors in Parallel

The main advantage of connecting aluminum capacitors in parallel is that the ripple current is shared by the devices. Two identical aluminum capacitors in parallel, for example, each see about half the ripple current value and, therefore, the value for I_A/I_R is halved. As temperature rise is proportional to the square of I_A/I_R (see Equation 6), the rise will be only one quarter of the increase that occurs when a single aluminum capacitor is used. Assuming $I_A/I_R > 1$, this can result in a significant extension to capacitor lifetime.

The temperature, frequency, and time dependent electrical characteristics of aluminum capacitors must be taken into account when considering connecting these devices in parallel to share the ripple current. As the voltage U_f over each aluminum capacitor is the same, the ripple current I_f through each aluminum capacitor is determined by its impedance Z_f (f being the frequency of the ripple current). Using the simple electrical model in Figure 3, this leads to the following expression for the ripple current:

$$I_f = U_f / Z_f \text{ with } Z_f = \sqrt{\left(\frac{1}{2\pi f C_f}\right)^2 + \text{ESR}_f^2} \quad [11]$$

At the high frequencies of most power supplies, ESR_f will be the dominant term in the impedance. This means that the aluminum capacitor with the lowest ESR_f will handle the highest ripple current and, therefore, run at the highest temperature. This high temperature will induce an accelerated aging process causing the ohmic losses (ESR_f) to increase faster over time. This will result in a decrease in its share of the total ripple current and a decrease in its temperature. The other aluminum capacitors' share of the total ripple current will increase, however, as will their temperature and rate of aging. This ripple current 'balancing' ultimately ensures that the lifetime of the capacitors in parallel will be similar to the value calculated.

For low frequencies of typically twice the mains frequency, the term containing C_f is the dominant term in the impedance. As a result, the aluminum capacitor with the highest C_f will handle the highest ripple current and run at the highest temperature, inducing an accelerated aging process. Again, this means that its ohmic losses (ESR_f) increase faster over time. However, if the value for C_f does not change significantly, this aluminum capacitor will continue to handle the highest ripple current. In this case, the lifetime of the capacitors in parallel can be expected to be shorter than the value calculated.

In most power supplies, the mains input buffer capacitor operates at $I_A / I_R < 1$, so the self heating due to ohmic losses does not have a significant influence on lifetime. The shortening of lifetime due to the ripple current sharing described above will therefore not be significant.

Connecting Aluminum Capacitors in Series

Sometimes the rated voltage of suitable aluminum capacitors is lower than the voltage that they must withstand. In that case, two or more aluminum capacitors must be connected in series to ensure that the rated voltage of the individual aluminum capacitor is not exceeded.

Connecting aluminum capacitors in series requires balancing resistors to counteract the fact that leakage current for the devices can be quite different at the same applied voltage. Because of this, forcing the same current through each aluminum capacitor will not lead to an even distribution of voltage and could result in one of the devices being subjected to a voltage in excess of its maximum rating. To avoid this, parallel balancing resistors as shown in Figure 10 are needed to limit the difference in voltage across the aluminum capacitors under DC conditions.



ALUMINUM CAPACITORS

Other Practical Issues



The following can be used to calculate the maximum possible resistor values for the case where two aluminum capacitors are connected in series:

$$R = \frac{2 \cdot U_m - U_{total}}{I_{L5}} \quad [12]$$

U_m is the maximum voltage that may be present on one of the aluminum capacitors (usually the rated voltage) and I_{L5} is the specified leakage current in amps after five minutes (used as an approximation of the difference in leakage current between C_1 and C_2).

Mechanical Considerations

Naturally, the aluminum capacitor chosen must fit the target power supply, so it is important to verify maximum dimensions rather than rely on the nominal dimensions specified in data books. Typically the lower the voltage and maximum temperature ratings, the smaller the device volume. Be aware, though, that miniaturized aluminum capacitors sometimes have shorter lifetimes than larger devices. For applications where height is particularly restricted, axial style aluminum capacitors may be more appropriate.

It should be noted that many aluminum capacitor series also offer a variety of pinning and lead configurations. For example, the three pin SI configuration was developed to prevent reverse mounting while maintaining compatibility with the standard two pin SI configuration. This is important as reverse mounting cannot be detected by other methods than visual inspection.

In addition, special modifications to the standard mechanical design are available to allow the aluminum capacitor to handle vibration levels higher than the standard ratings.

Figure 10. Balancing Resistors

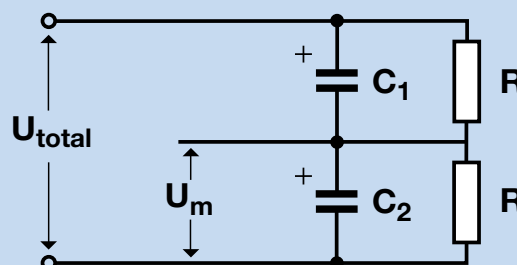



ALUMINUM CAPACITORS

Aluminum Capacitors from Vishay



Capacitors - Aluminum in Power Supplies

Vishay offers a very broad range of aluminum capacitors and Table 2 illustrates a small selection of these devices as they apply to different power ratings and circuit positions. Information on other devices, as well as in-depth technical information, can be found on the Vishay website (www.vishay.com/capacitors/aluminum/). However, if you do not find an aluminum capacitor on the website that has exactly the characteristics you need, or if you have any special requirements, do not hesitate to contact your local sales representative.

Table 2. Starting Points for Aluminum Capacitor Series Used in Power Supplies			
Circuit Position	Approximate Power Range	Possible Series	Remarks
Input buffer (< 100 V)	0 W to 20 W	150 CRZ	Lowest ESR, 105 °C, SMD
		146 CTI	Low ESR, 125 °C, SMD
		150 RMI	Lowest ESR, 105 °C, long life, small size
		146 RTI	Low ESR, 125 °C, long life
		120 ATC	125 °C, axial
	20 W to 200 W	158 PUL-SI	105 °C, low ESR, long life
Input buffer (≥100 V)	0 W to 50 W	152 RMH	105 °C, long life, small size
		142 RHS	105 °C, general purpose
	50 W to 300 W	094 PME-SI	105 °C, small size
		157 PUM-SI	85 °C, long life
		159 PUL-SI	105 °C, long life
Output buffer (< 100 V)	0 W to 50 W	150 CRZ	Lowest ESR, 105 °C, SMD
		146 CTI	Low ESR, 125 °C, SMD
		142 RHS	105 °C, general purpose
	50 W to 300 W	150 RMI	Lowest ESR, 105 °C, long life, small size
		146 RTI	Low ESR, 125 °C, long life
		120 ATC	125 °C, axial
		128 SAL-RPM	125 °C, small size, very long life
Output buffer (≥ 100 V)	0 W to 300 W	152 RMH	105 °C, long life, small size
		142 RHS	105 °C, general purpose