

## 1 Form B Solid State Relay

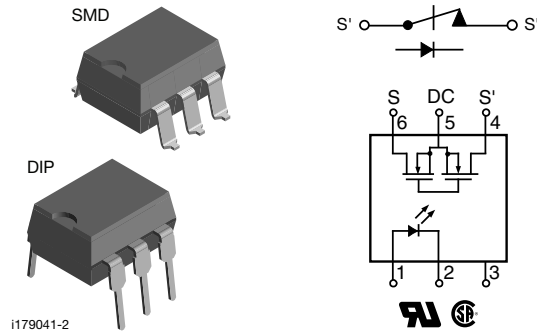

### FEATURES

- Isolation test voltage 3750 V<sub>RMS</sub>
- Typical R<sub>ON</sub> 20 Ω
- Load voltage 350 V
- Clean bounce free switching
- Low power consumption
- SMD lead available on tape and reel
- Material categorization: for definitions of compliance please see [www.vishay.com/doc?99912](http://www.vishay.com/doc?99912)

**RoHS**  
COMPLIANT

### LINKS TO ADDITIONAL RESOURCES



### DESCRIPTION

The LH1501 relays are SPST normally closed switches (1 form B) that can replace electromechanical relays in many applications. The relays are constructed as a multi-chip hybrid device. Actuation control is via an infrared LED. The output switch is a combination of a photodiode array with MOSFET switches and control circuitry. The relays can be configured for AC/DC or DC only operation.

### APPLICATIONS

- General telecom switching
- Security equipment
- Instrumentation
- Industrial controls

### AGENCY APPROVALS

- [UL](#)
- [VDE](#)

ORDERING INFORMATION												
L	H	1	5	0	1	B	#	#	T	R		
PART NUMBER						ELECTR. VARIATION	PACKAGE CONFIG.		TAPE AND REEL			
<b>PACKAGE</b>						<b>UL, CSA</b>						
SMD-6, tubes						LH1501BAB						
SMD-6, tape and reel						LH1501BABTR						
DIP-6, tubes						LH1501BT						



ABSOLUTE MAXIMUM RATINGS (T <sub>amb</sub> = 25 °C, unless otherwise specified)				
PARAMETER	TEST CONDITION	SYMBOL	VALUE	UNIT
<b>INPUT</b>				
LED continuous forward current		I <sub>F</sub>	50	mA
LED reverse voltage	I <sub>R</sub> ≤ 10 μA	V <sub>R</sub>	5	V
<b>OUTPUT</b>				
DC or peak AC load voltage	I <sub>L</sub> ≤ 50 μA	V <sub>L</sub>	350	V
Continuous DC load current - bidirectional		I <sub>L</sub>	150	mA
Continuous DC load current - unidirectional		I <sub>L</sub>	200	mA
Peak load current (single shot)	t = 100 ms	I <sub>P</sub>	350	mA
<b>SSR</b>				
Ambient temperature range		T <sub>amb</sub>	-40 to +85	°C
Storage temperature range		T <sub>stg</sub>	-40 to +125	°C
Pin soldering temperature <sup>(1)</sup>	t = 10 s max.	T <sub>sld</sub>	260	°C
Input to output isolation voltage	t = 1 s, I <sub>ISO</sub> = 10 μA max.	V <sub>ISO</sub>	3750	V <sub>RMS</sub>
Output power dissipation (continuous)		P <sub>diss</sub>	550	mW

**Notes**

- Stresses in excess of the absolute maximum ratings can cause permanent damage to the device. Functional operation of the device is not implied at these or any other conditions in excess of those given in the operational sections of this document. Exposure to absolute maximum ratings for extended periods of the time can adversely affect reliability
- <sup>(1)</sup> Refer to reflow profile for soldering conditions for surface mounted devices (SMD). Refer to wave profile for soldering conditions for through hole devices (DIP)

ELECTRICAL CHARACTERISTICS (T <sub>amb</sub> = 25 °C, unless otherwise specified)						
PARAMETER	TEST CONDITION	SYMBOL	MIN.	TYP.	MAX.	UNIT
<b>INPUT</b>						
LED forward current, switch turn-on	I <sub>L</sub> = ± 150 mA, t = 10 ms	I <sub>Fon</sub>	0.2	0.9		mA
LED forward current, switch turn-off	V <sub>L</sub> = ± 300 V	I <sub>Foff</sub>		1	2	mA
LED forward voltage	I <sub>F</sub> = 10 mA	V <sub>F</sub>	1.15	1.26	1.45	V
<b>OUTPUT</b>						
On-resistance, AC/DC: pin 4, 6 (+) to 5 (-)	I <sub>F</sub> = 0 mA, I <sub>L</sub> = 50 mA	R <sub>ON</sub>		20	25	Ω
On-resistance, DC: pin 4, 6 (+) to 5 (-)	I <sub>F</sub> = 0 mA, I <sub>L</sub> = 100 mA	R <sub>ON</sub>		5	6.25	Ω
Off-resistance	I <sub>F</sub> = 5 mA, V <sub>L</sub> = ± 100 V	R <sub>OFF</sub>	0.1	1.4		GΩ
Off-state leakage current	I <sub>F</sub> = 5 mA, V <sub>L</sub> = ± 350 V	I <sub>O</sub>		0.08	1	μA
Output capacitance	I <sub>F</sub> = 5 mA, V <sub>L</sub> = 50 V	C <sub>O</sub>		35		pF
<b>TRANSFER</b>						
Capacitance (input to output)	V <sub>ISO</sub> = 1 V	C <sub>IO</sub>		3		pF

**Note**

- Minimum and maximum values are testing requirements. Typical values are characteristics of the device and are the result of engineering evaluations. Typical values are for information only and are not part of the testing requirements.

SWITCHING CHARACTERISTICS (T <sub>amb</sub> = 25 °C, unless otherwise specified)						
PARAMETER	TEST CONDITION	SYMBOL	MIN.	TYP.	MAX.	UNIT
Turn-on time	I <sub>F</sub> = 5 mA, I <sub>L</sub> = 50 mA	t <sub>on</sub>		2	3	ms
Turn-off time	I <sub>F</sub> = 5 mA, I <sub>L</sub> = 50 mA	t <sub>off</sub>		1	3	ms



## TYPICAL CHARACTERISTICS (T<sub>amb</sub> = 25 °C, unless otherwise specified)

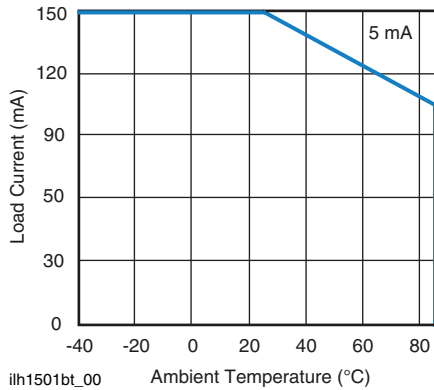
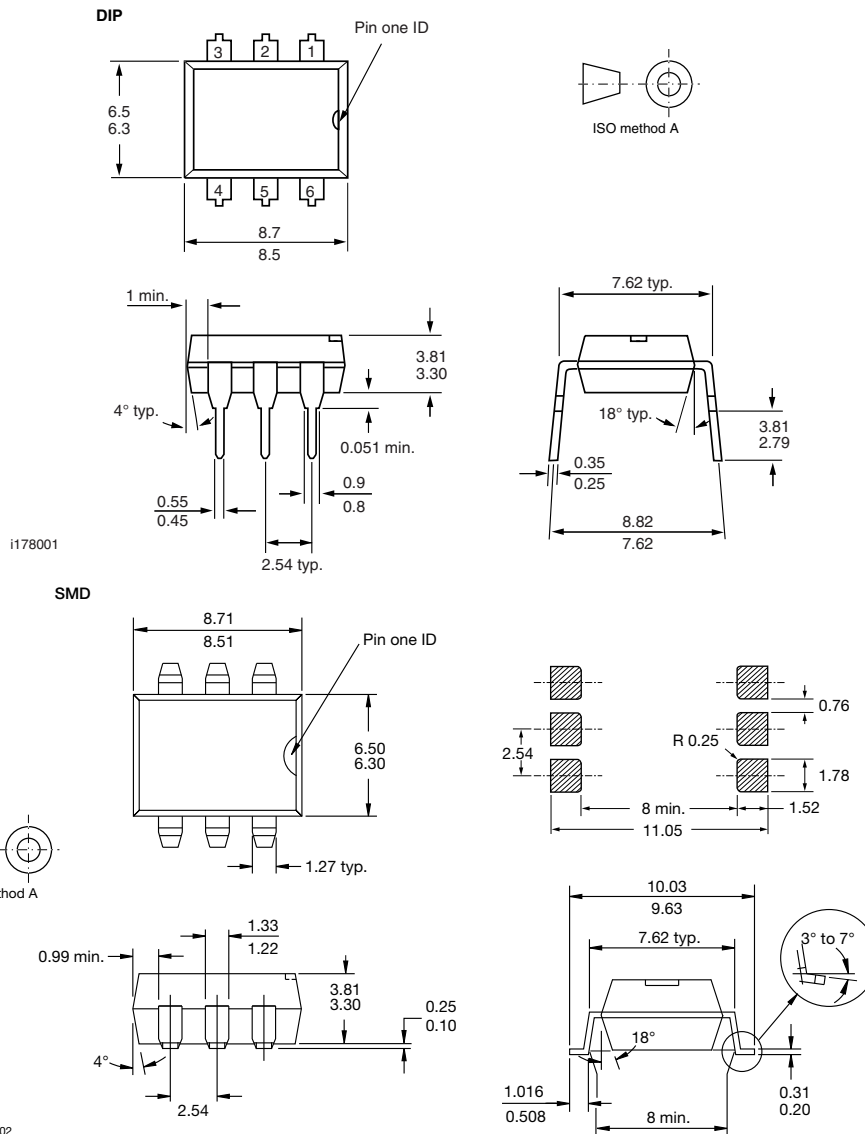
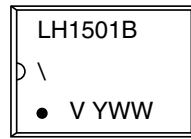

Fig. 1 - Maximum Load Current vs. Ambient Temperature

## PACKAGE DIMENSIONS in millimeters



## PACKAGE MARKING (example)



### Note

- Tape and reel suffix (TR) is not part of the package marking

## SOLDER PROFILES

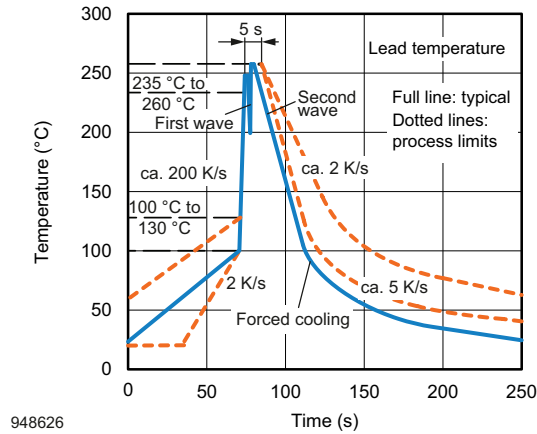

948626

Fig. 2 - Wave Soldering Double Wave Profile  
According to J-STD-020 for DIP Devices

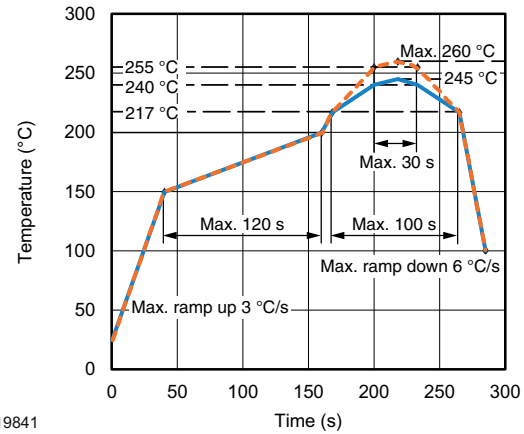

19841

Fig. 3 - Lead (Pb)-free Reflow Solder Profile  
According to J-STD-020 for SMD Devices

## HANDLING AND STORAGE CONDITIONS

ESD level: HBM class 2

Floor life: unlimited

Conditions:  $T_{amb} < 30\text{ °C}$ , RH < 85 %

Moisture sensitivity level 1, according to J-STD-020



## Footprint and Schematic Information for LH1501BAB, LH1501BABTR, LH1501BT

The footprint and schematic symbols for the following parts can be accessed using the associated links. They are available in Eagle, Altium, KiCad, OrCAD / Allegro, Pulsonix, and PADS.

Note that the 3D models for these parts can be found on the Vishay product page.

PART NUMBER	FOOTPRINT / SCHEMATIC
LH1501BAB	<a href="http://www.snapeda.com/parts/LH1501BAB/Vishay/view-part">www.snapeda.com/parts/LH1501BAB/Vishay/view-part</a>
LH1501BABTR	<a href="http://www.snapeda.com/parts/LH1501BABTR/Vishay/view-part">www.snapeda.com/parts/LH1501BABTR/Vishay/view-part</a>
LH1501BT	<a href="http://www.snapeda.com/parts/LH1501BT/Vishay/view-part">www.snapeda.com/parts/LH1501BT/Vishay/view-part</a>

For technical issues and product support, please contact [optocoupleranswers@vishay.com](mailto:optocoupleranswers@vishay.com).

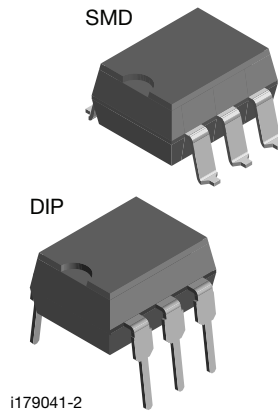



## Disclaimer

ALL PRODUCT, PRODUCT SPECIFICATIONS AND DATA ARE SUBJECT TO CHANGE WITHOUT NOTICE TO IMPROVE RELIABILITY, FUNCTION OR DESIGN OR OTHERWISE.

Vishay Intertechnology, Inc., its affiliates, agents, and employees, and all persons acting on its or their behalf (collectively, "Vishay"), disclaim any and all liability for any errors, inaccuracies or incompleteness contained in any datasheet or in any other disclosure relating to any product.

Vishay makes no warranty, representation or guarantee regarding the suitability of the products for any particular purpose or the continuing production of any product. To the maximum extent permitted by applicable law, Vishay disclaims (i) any and all liability arising out of the application or use of any product, (ii) any and all liability, including without limitation special, consequential or incidental damages, and (iii) any and all implied warranties, including warranties of fitness for particular purpose, non-infringement and merchantability.

Statements regarding the suitability of products for certain types of applications are based on Vishay's knowledge of typical requirements that are often placed on Vishay products in generic applications. Such statements are not binding statements about the suitability of products for a particular application. It is the customer's responsibility to validate that a particular product with the properties described in the product specification is suitable for use in a particular application. Parameters provided in datasheets and / or specifications may vary in different applications and performance may vary over time. All operating parameters, including typical parameters, must be validated for each customer application by the customer's technical experts. Product specifications do not expand or otherwise modify Vishay's terms and conditions of purchase, including but not limited to the warranty expressed therein.

Hyperlinks included in this datasheet may direct users to third-party websites. These links are provided as a convenience and for informational purposes only. Inclusion of these hyperlinks does not constitute an endorsement or an approval by Vishay of any of the products, services or opinions of the corporation, organization or individual associated with the third-party website. Vishay disclaims any and all liability and bears no responsibility for the accuracy, legality or content of the third-party website or for that of subsequent links.

Except as expressly indicated in writing, Vishay products are not designed for use in medical, life-saving, or life-sustaining applications or for any other application in which the failure of the Vishay product could result in personal injury or death. Customers using or selling Vishay products not expressly indicated for use in such applications do so at their own risk. Please contact authorized Vishay personnel to obtain written terms and conditions regarding products designed for such applications.

No license, express or implied, by estoppel or otherwise, to any intellectual property rights is granted by this document or by any conduct of Vishay. Product names and markings noted herein may be trademarks of their respective owners.