



| ABSOLUTE MAXIMUM RATINGS ($T_{amb} = 25\text{ }^{\circ}\text{C}$, unless otherwise specified) | | | | |
|---|------------------------|------------|-------------|--------------------|
| PARAMETER | CONDITIONS | SYMBOL | VALUE | UNIT |
| INPUT | | | | |
| IRED continuous forward current | | I_F | 50 | mA |
| IRED reverse voltage | | V_R | 5 | V |
| Input power dissipation | | P_{diss} | 80 | mW |
| Junction temperature | | T_j | 125 | $^{\circ}\text{C}$ |
| OUTPUT | | | | |
| DC or peak AC load voltage | | V_L | 400 | V |
| Continuous DC load current at 25 $^{\circ}\text{C}$, one channel | | I_L | 140 | mA |
| Continuous DC load current at 25 $^{\circ}\text{C}$, two channels | | I_L | 100 | mA |
| SSR output power dissipation | | P_{diss} | 550 | mW |
| Junction temperature | | T_j | 125 | $^{\circ}\text{C}$ |
| SSR | | | | |
| Ambient temperature range | | T_{amb} | -40 to +100 | $^{\circ}\text{C}$ |
| Storage temperature range | | T_{stg} | -40 to +150 | $^{\circ}\text{C}$ |
| Soldering temperature | $t = 10\text{ s max.}$ | T_{sld} | 260 | $^{\circ}\text{C}$ |

Note

- Stresses in excess of the absolute maximum ratings can cause permanent damage to the device. Functional operation of the device is not implied at these or any other conditions in excess of those given in the operational sections of this document. Exposure to absolute maximum ratings for extended periods of the time can adversely affect reliability.

| ELECTRICAL CHARACTERISTICS ($T_{amb} = 25\text{ }^{\circ}\text{C}$, unless otherwise specified) | | | | | | |
|---|---|------------|------|------|------|------------------|
| PARAMETER | TEST CONDITION | SYMBOL | MIN. | TYP. | MAX. | UNIT |
| INPUT | | | | | | |
| IRED forward current, switch turn-on | $I_L = 100\text{ mA}$, $t = 10\text{ ms}$ | I_{Fon} | - | 0.25 | 2 | mA |
| IRED forward current, switch turn-off | $V_L = \pm 350\text{ V}$ | I_{Foff} | 0.05 | 0.15 | - | mA |
| IRED forward voltage | $I_F = 10\text{ mA}$ | V_F | - | 1.4 | 1.6 | V |
| IRED reverse current | $V_R = 5\text{ V}$ | I_R | - | - | 10 | μA |
| OUTPUT | | | | | | |
| On-resistance | $I_F = 5\text{ mA}$, $I_L = 50\text{ mA}$ | R_{ON} | - | 22 | 27 | Ω |
| Off-resistance | $I_F = 0\text{ mA}$, $V_L = \pm 100\text{ V}$ | R_{OFF} | 1 | 5000 | - | $\text{G}\Omega$ |
| Off-state leakage current | $I_F = 0\text{ mA}$, $V_L = \pm 100\text{ V}$ | I_O | - | < 1 | 100 | nA |
| | $I_F = 0\text{ mA}$, $V_L = \pm 400\text{ V}$ | I_O | - | 6 | 500 | nA |
| Output capacitance | $I_F = 0\text{ mA}$, $V_L = 1\text{ V}$, 1 MHz | C_O | - | 39 | - | pF |
| | $I_F = 0\text{ mA}$, $V_L = 50\text{ V}$, 1 MHz | C_O | - | 6 | - | pF |
| TRANSFER | | | | | | |
| Capacitance (input to output) | $V_{IO} = 1\text{ V}$ | C_{IO} | - | 1 | - | pF |

Note

- Minimum and maximum values are testing requirements. Typical values are characteristics of the device and are the result of engineering evaluations. Typical values are for information only and are not part of the testing requirements.

| SWITCHING CHARACTERISTICS ($T_{amb} = 25\text{ }^{\circ}\text{C}$, unless otherwise specified) | | | | | | |
|--|--|-----------|------|------|------|------|
| PARAMETER | TEST CONDITION | SYMBOL | MIN. | TYP. | MAX. | UNIT |
| Turn-on time | $I_F = 5\text{ mA}$, $I_L = 50\text{ mA}$ | t_{on} | - | 0.13 | 0.5 | ms |
| Turn-off time | $I_F = 5\text{ mA}$, $I_L = 50\text{ mA}$ | t_{off} | - | 0.05 | 0.2 | ms |

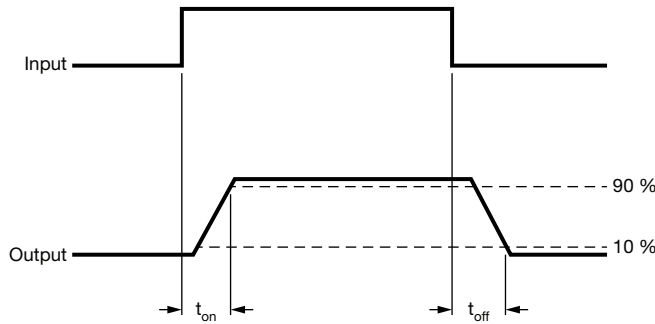
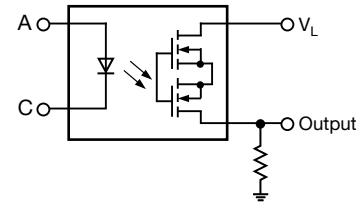

Fig. 1 - Timing Schematic



| SAFETY AND INSULATION RATINGS | | | | |
|--|--|------------|----------------|--------------------|
| PARAMETER | TEST CONDITION | SYMBOL | VALUE | UNIT |
| Climatic classification | According to IEC 68 part 1 | | 40 / 100 / 21 | |
| Pollution degree | According to DIN VDE 0109 | | 2 | |
| Comparative tracking index | Insulation group IIIa | CTI | 175 | |
| Maximum rated withstanding isolation voltage | According to UL1577, t = 1 min | V_{ISO} | 5300 | V_{RMS} |
| Maximum transient isolation voltage | According to DIN EN 60747-5-5 | V_{IOTM} | 8000 | V_{peak} |
| Maximum repetitive peak isolation voltage | According to DIN EN 60747-5-5 | V_{IORM} | 890 | V_{peak} |
| Isolation resistance | $V_{IO} = 500\text{ V}, T_{amb} = 25\text{ }^{\circ}\text{C}$ | R_{IO} | $\geq 10^{12}$ | Ω |
| | $V_{IO} = 500\text{ V}, T_{amb} = 100\text{ }^{\circ}\text{C}$ | R_{IO} | $\geq 10^{11}$ | Ω |
| Output safety power | | P_{SO} | 640 | mW |
| Input safety current | | I_{SI} | 240 | mA |
| Safety temperature | | T_S | 175 | $^{\circ}\text{C}$ |
| Creepage distance | DIP-8 | | ≥ 7 | mm |
| Clearance distance | DIP-8 | | ≥ 7 | mm |
| Creepage distance | SMD-8 | | ≥ 8 | mm |
| Clearance distance | SMD-8 | | ≥ 8 | mm |
| Insulation thickness | | DTI | ≥ 0.4 | mm |
| Input to output test voltage, method B | $V_{IORM} \times 1.875 = V_{PR}$, 100 % production test with $t_M = 1\text{ s}$, partial discharge $< 5\text{ pC}$ | V_{PR} | 1669 | V_{peak} |
| Input to output test voltage, method A | $V_{IORM} \times 1.6 = V_{PR}$, 100 % sample test with $t_M = 10\text{ s}$, partial discharge $< 5\text{ pC}$ | V_{PR} | 1424 | V_{peak} |

Note

- As per IEC 60747-5-5, § 7.4.3.8.2, this optocoupler is suitable for “safe electrical insulation” only within the safety ratings. Compliance with the safety ratings shall be ensured by means of protective circuits.

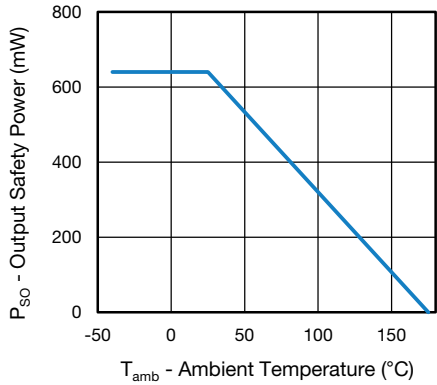

Fig. 2 - Safety Power Dissipation vs. Ambient Temperature

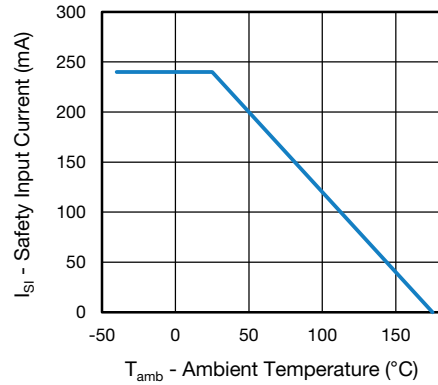

Fig. 3 - Safety Input Current vs. Ambient Temperature

TYPICAL CHARACTERISTICS ($T_{amb} = 25\text{ }^{\circ}\text{C}$, unless otherwise specified)

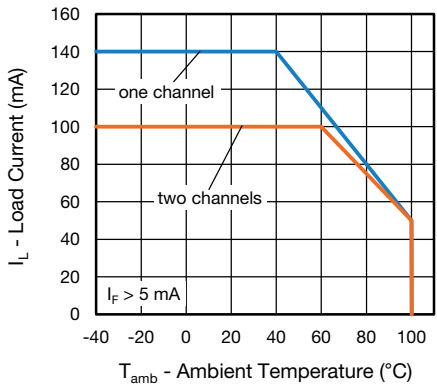

Fig. 4 - Maximum Load Current vs. Ambient Temperature

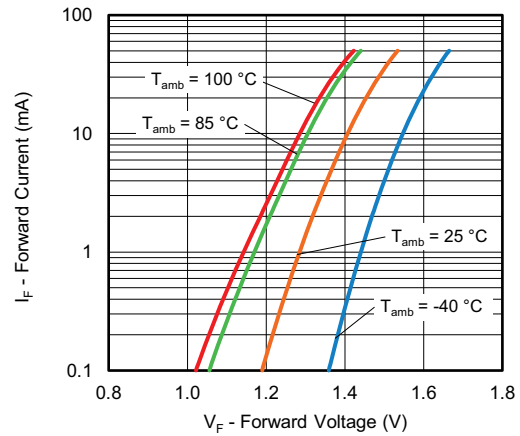

Fig. 6 - Forward Current vs. Forward Voltage

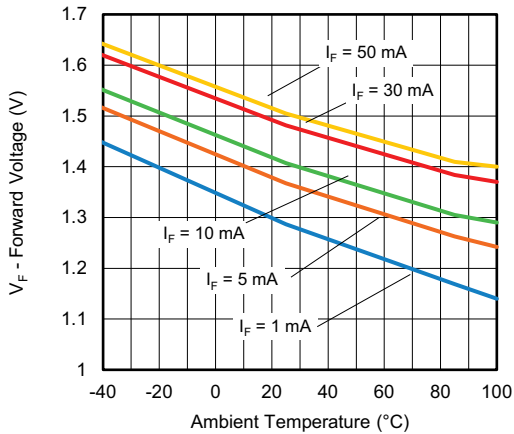

Fig. 5 - Forward Voltage vs. Ambient Temperature

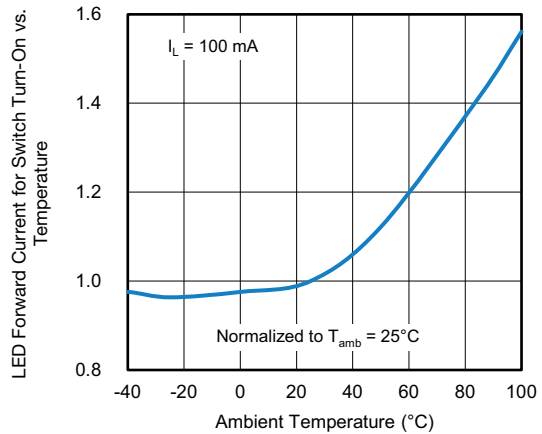

Fig. 7 - Normalized Forward Current for Switch Turn-On vs. Ambient Temperature

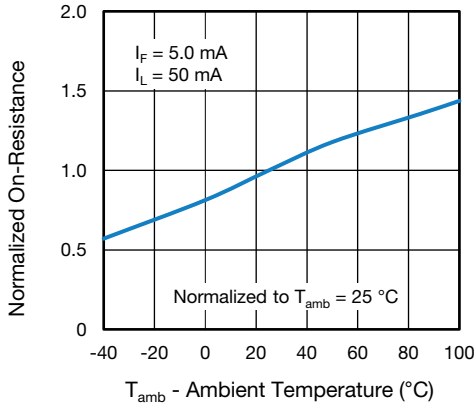

Fig. 8 - Normalized On-Resistance vs. Ambient Temperature

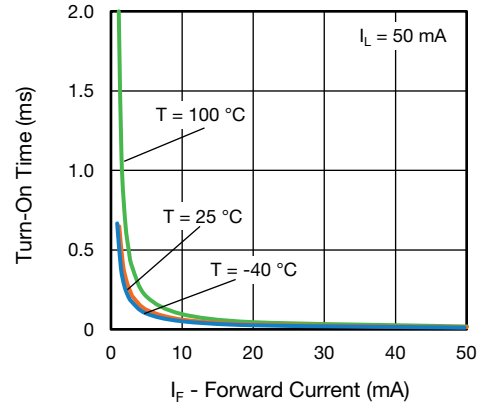

Fig. 11 - Turn-On Time vs. Forward Current

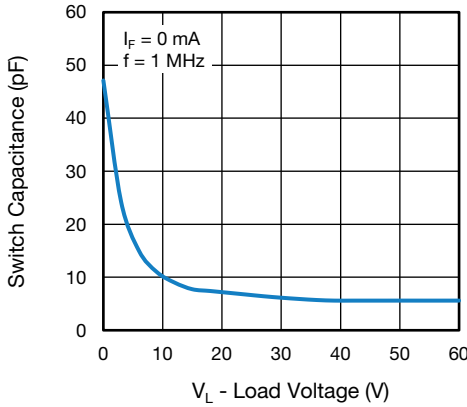

Fig. 9 - Output Capacitance vs. Load Voltage

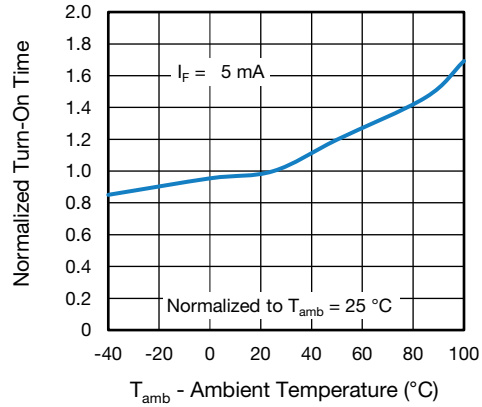

Fig. 12 - Normalized Turn-On Time vs. Ambient Temperature

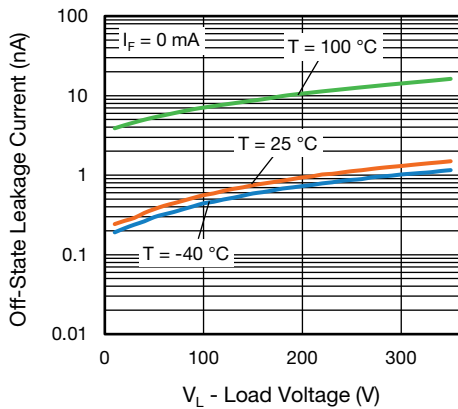

Fig. 10 - Off-State Leakage Current vs. Load Voltage

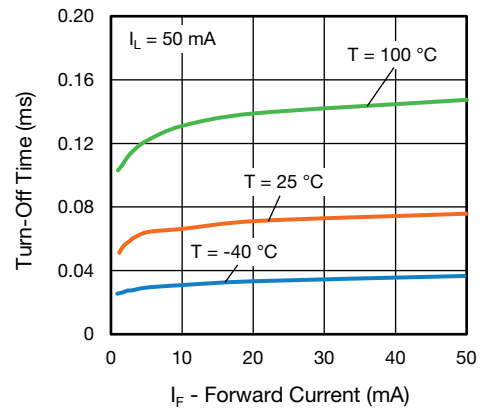

Fig. 13 - Turn-Off Time vs. Forward Current

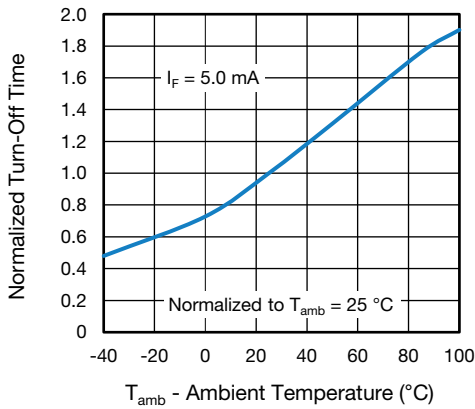
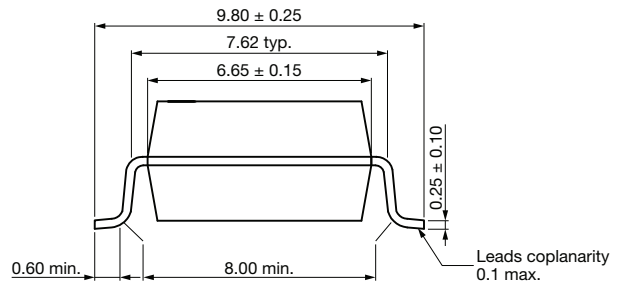
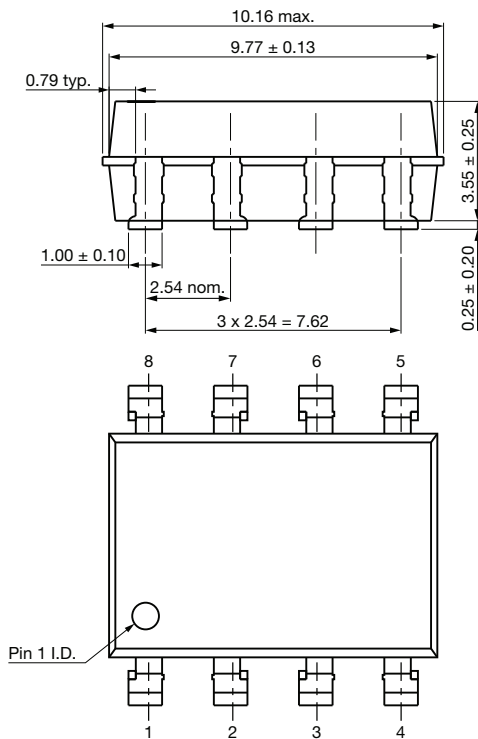

Fig. 14 - Normalized Turn-Off Time vs. Ambient Temperature

PACKAGE DIMENSIONS (in millimeters)

SMD-8



Recommended footprint

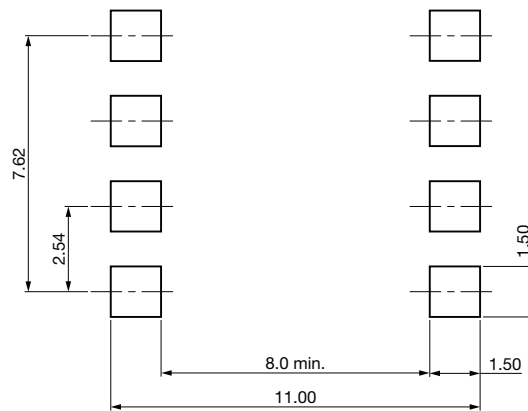



DIP-8

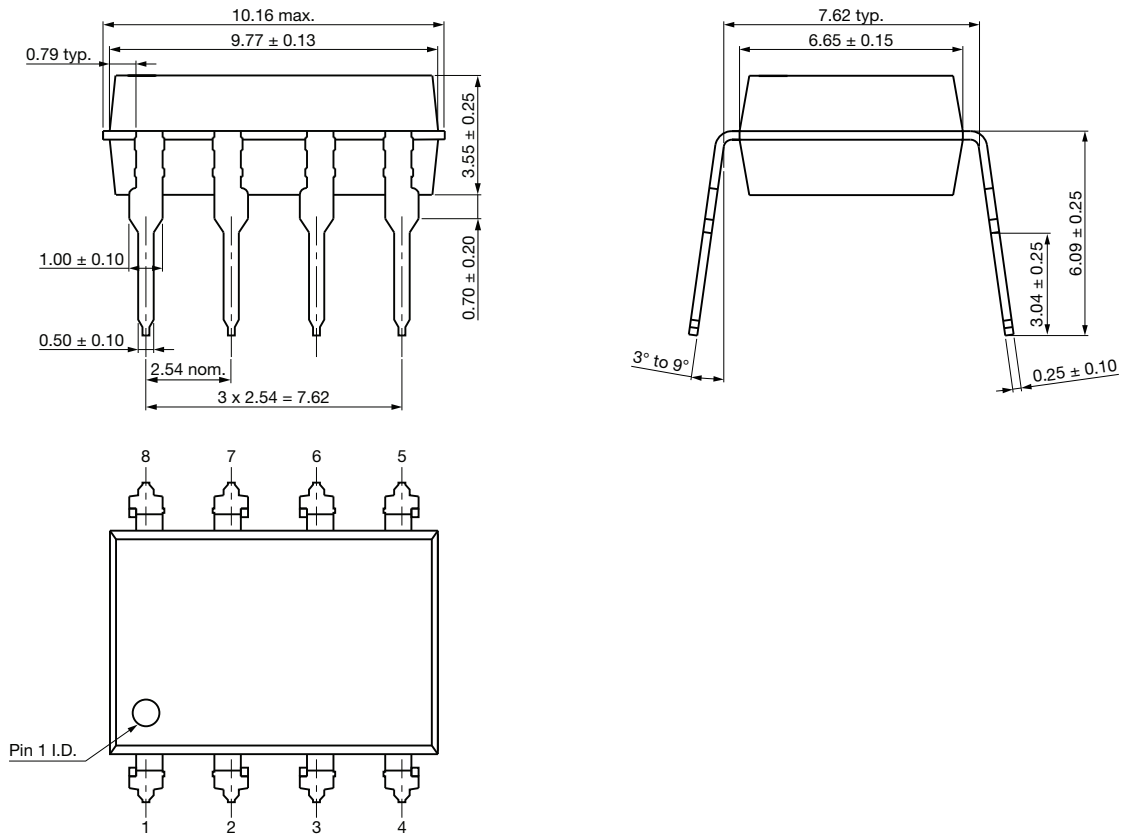

PACKAGE MARKING (example)

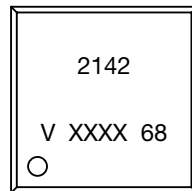

Fig. 15 - VOR2142

Notes

- XXXX = LMC (lot marking code)
- Tape and reel suffix (TR) is not part of the package marking



Footprint and Schematic Information for VOR2142

The footprint and schematic symbols for the following parts can be accessed using the associated links. They are available in Eagle, Altium, KiCad, OrCAD / Allegro, Pulsonix, and PADS.

Note that the 3D models for these parts can be found on the Vishay product page.

| PART NUMBER | FOOTPRINT / SCHEMATIC |
|-------------|--|
| VOR2142A8 | www.snapeda.com/parts/VOR2142A8/Vishay/view-part |
| VOR2142B8 | www.snapeda.com/parts/VOR2142B8/Vishay/view-part |
| VOR2142B8T | www.snapeda.com/parts/VOR2142B8T/Vishay/view-part |

For technical issues and product support, please contact optocoupleranswers@vishay.com.

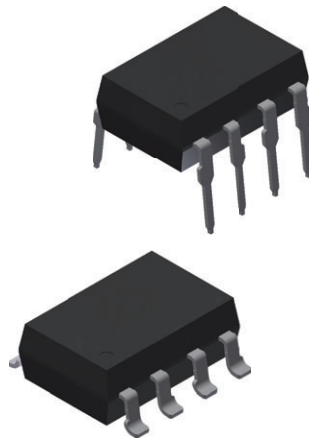



Disclaimer

ALL PRODUCT, PRODUCT SPECIFICATIONS AND DATA ARE SUBJECT TO CHANGE WITHOUT NOTICE TO IMPROVE RELIABILITY, FUNCTION OR DESIGN OR OTHERWISE.

Vishay Intertechnology, Inc., its affiliates, agents, and employees, and all persons acting on its or their behalf (collectively, "Vishay"), disclaim any and all liability for any errors, inaccuracies or incompleteness contained in any datasheet or in any other disclosure relating to any product.

Vishay makes no warranty, representation or guarantee regarding the suitability of the products for any particular purpose or the continuing production of any product. To the maximum extent permitted by applicable law, Vishay disclaims (i) any and all liability arising out of the application or use of any product, (ii) any and all liability, including without limitation special, consequential or incidental damages, and (iii) any and all implied warranties, including warranties of fitness for particular purpose, non-infringement and merchantability.

Statements regarding the suitability of products for certain types of applications are based on Vishay's knowledge of typical requirements that are often placed on Vishay products in generic applications. Such statements are not binding statements about the suitability of products for a particular application. It is the customer's responsibility to validate that a particular product with the properties described in the product specification is suitable for use in a particular application. Parameters provided in datasheets and / or specifications may vary in different applications and performance may vary over time. All operating parameters, including typical parameters, must be validated for each customer application by the customer's technical experts. Product specifications do not expand or otherwise modify Vishay's terms and conditions of purchase, including but not limited to the warranty expressed therein.

Hyperlinks included in this datasheet may direct users to third-party websites. These links are provided as a convenience and for informational purposes only. Inclusion of these hyperlinks does not constitute an endorsement or an approval by Vishay of any of the products, services or opinions of the corporation, organization or individual associated with the third-party website. Vishay disclaims any and all liability and bears no responsibility for the accuracy, legality or content of the third-party website or for that of subsequent links.

Except as expressly indicated in writing, Vishay products are not designed for use in medical, life-saving, or life-sustaining applications or for any other application in which the failure of the Vishay product could result in personal injury or death. Customers using or selling Vishay products not expressly indicated for use in such applications do so at their own risk. Please contact authorized Vishay personnel to obtain written terms and conditions regarding products designed for such applications.

No license, express or implied, by estoppel or otherwise, to any intellectual property rights is granted by this document or by any conduct of Vishay. Product names and markings noted herein may be trademarks of their respective owners.